

zubler® Vacuum Suction Systems

Appropriate solutions for any laboratory



Grinding without suction?

Laboratory technicians would occasionally prefer to turn off their vacuum during grinding.

Even during milling or grinding jobs that scarcely involve any reduction of material, fine dust is always created. You cannot see them, and yet they are whirling and hovering across the room. With your head located close to the instrument tip, you will inevitably inhale particles in high concentrations even when performing grinding jobs that you may consider perfectly harmless. It is precisely these fine dust particles that will penetrate deeply into the lungs with ease. Common particles from alveolar bone (< 5 µm in diameter) can become lodged in the lungs and turn into a source of chronic asthmatic conditions and severe lung disease.

Think about it! We are talking about your health. You perform these jobs almost daily.

Occupational health and safety are non-negotiable

If dental laboratories fail to use suction, most dust that is generated will clearly exceed occupational exposure limits.

Suction to eliminate dusts is invariably required by German regulations governing the use of hazardous substances. Furthermore, all vacuum systems must be mandatorily tested for effectiveness at least once a year.

We support you with our experience

Dust exposure can be dramatically reduced by the use of optimized funnel systems and state-of-the-art vacuum equipment.

Vacuum systems are particularly effective if they convey exhaust air to the outside of the building. This will also improve the indoor climate throughout the laboratory.

Zubler offers a number of vacuum options, so you can always select a solution that is optimized for the needs of your laboratory.

Turn on your vacuum – always!

Even vacuum systems not using the latest technology will usually reduce dust levels around the workspace. However, you should make an effort to improve the situation before there is a problem.

Single suction unit

Multi suction unit

Central suction system

Accessories

Dust in dental technology: a big occupational hazard!

Dental technicians are especially at risk. According to statistics by the BGFE (German Occupational Society for Precision and Electrical Engineering), occupational skin and lung diseases are considerably more prevalent among dental technicians than the BGFE average. Fine airborne particles are especially dangerous. Highly detrimental effects on the skin and respiratory organs have also been identified for dental gypsum and investment materials. The same is true of non-classified particles with general exposure limits.

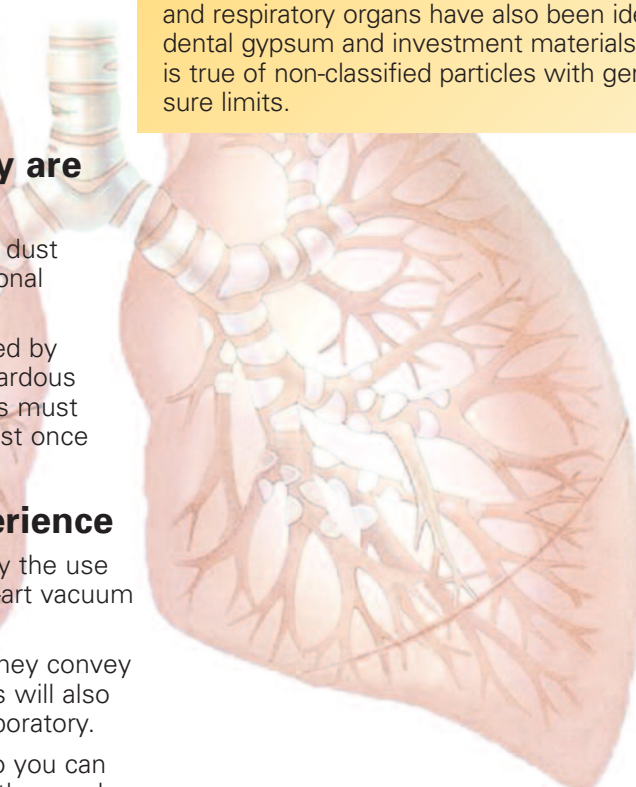

Product range selection

Single suction unit



Model

Vac. ports

V4000

1

Z1 ECO

1

Z1 CAM

1

Z1 ECO PRO

1

Z1 CAM PRO

1

Z1-AT

1

Various models with different filters and suction motors are offered, which are optimized for different dust loads and applications.

Multi suction unit



FZ1 VARIOmaster®

2 (4)

FZ2 VARIOmatic®

4 (6)

All of our multiple-position units are equipped with non-brush motors and permanent filter systems. The dust is collected in a container. Although these systems are more expensive, they are highly economical in the long run.

Central suction system



FZ VARIO

>6

Central vacuum systems offer the best working environment. They are the cleanest and quietest performers. Whenever a solution for a larger number of vacuum positions needs to be found, it is a good idea to analyze whether a central system might be economical and could be accommodated.

Accessories



SH-1

Suction hood

R1200

Large vacuum funnel

R1250

Small vacuum funnel

R1260

Gold filter insert

R1000

Rectangular pipe

R1300

Adjustable pipe

El. power (W)		Air volume (l/s)		Noise (dB(A))		Exhaust outdoors	Exhaust indoors	Filterbag	Filter cartridge	Carbonbrush motor	Brushless motor	CAD / CAM
min.	max.	min.	max.	min.	max.							
250	650	25	36	55	65	●*	●	●	-	●	-	-
150	750	15	50	41	57	●	●	●	-	●	-	-
150	1000	15	65	41	65	●	●	●	-	●	-	●
150	750	15	50	54	63	●	●	-	●	●	-	-
150	1000	15	65	54	66	●	●	-	●	●	-	●
150	750	15	40	45	58	-	●	●	-	●	-	-
200	1200	16	65	48	67	●	●	-	●	-	●	-
420	2200	20	90	49	60	●	-	-	●	-	●	-
600	2500	20	300	(52)	(71)	●	-	-	●	-	●	●

R1500	Vacuum hood
R1600	Monomer bath
R1700	Spray Box
AV1000	Preparation station
MB1000	Monomer box
FG1000	Base
ST02	Vacuum plug
RS1+2	Cleaning acces.

* on request

V4000

Mobile suction

Workspace vacuum for installation and portable use

- Compact unit featuring an exchangeable filter door system.
- Continuous electronic control of vacuum power.
- Automatic on-off with connection to device.
- Switches off when the filter is full.
- Different bag filters and activated carbon filters are offered as accessories.



V4010 - V4011 - V4050



Filter technology of the V4000

All **V4000** units feature a dual filter system. Dirt is collected in the filter bag, which allows for easy removal and clean disposal without any dust escaping. A fine filter cartridge offers extra protection. It has longer replacement intervals.

Filter quality complies with dust category M as defined in EN 60335-2-69.

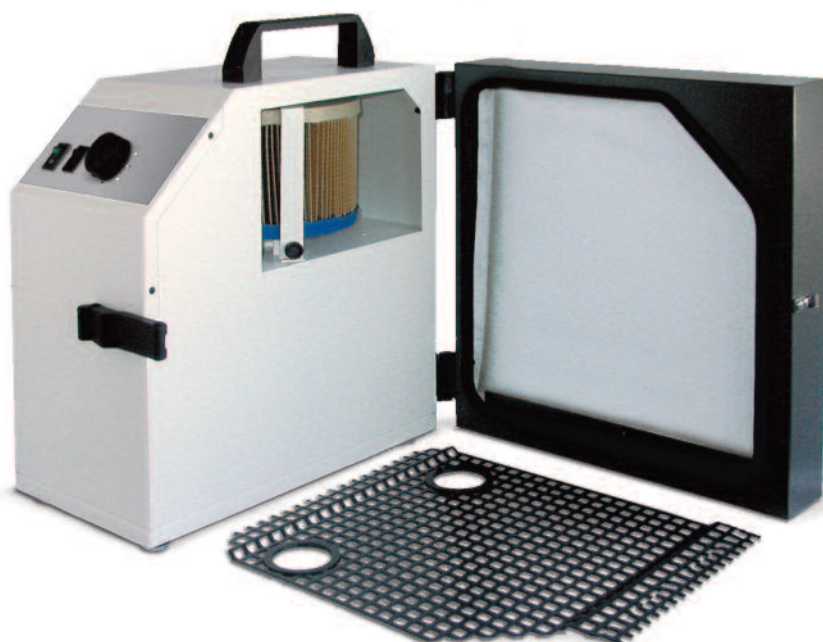

Filters

A side from the standard filter bag, a large filter bag is available for increased efficiency and extended service life in high-dirt applications. The large bag only works in conjunction with the wide **V4050** filter door, which is mutually compatible with the **V4000** unit to optimize versatility.



V4011 built-in version

The built-in version is suspended under the benchtop. With the mounting plate and matching rail available for this purpose, the unit can be readily installed and removed. Even the mobile unit is easily convertible to a built-in version. Just replace the carrying handle with the mounting rail (optional accessory).



An exchange floor with pipe socket (optional) allows connection to an exhaust duct to the outside.



Compact mobile suction

Device/workspace vacuum.

Offers a brushless motor.

- Compact unit featuring an exchangeable filter door system.
- Collectorless motor with continuous operation properties.
- Different bag filters and activated carbon filters are offered as accessories.

Activated charcoal filter

An activated charcoal filter can be inserted instead of the filter cartridge. Activated charcoal is capable of absorbing toxic vapours (for example, when resins are processed or monomers mixed). The activated charcoal filter is supplied as a refillable cartridge. Refill packs are available for convenient, environmentally friendly and inexpensive replacement of the charcoal.

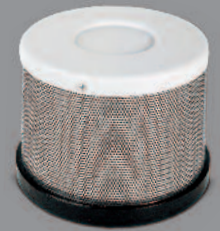

Technical Data

V4000

Dimensions:

Width:	small / wide door	265 / 375 mm
Height:	handle / mounting rail	435 / 415 mm
Depth:		400 mm
Weight:	small / wide door	20 / 25 kg
Power input:	suction unit	max. 700 W
	autom. socket	max. 450 W
Suction power:		18 - 35 l/s
Noise level:		55 - 65 dB(A)

Z1 ECO / Z1 CAM

Single work station suction unit

- With innovative Smart-Drive control for carbon brush motors
- Filter bag for normal up to high dust volume
- Sound level in operation from 41dB(A) to 57dB(A)
- Tool-free change of filter and motor
- Integrated Bluetooth module and Zubler Suction Technology App for individual settings, service and remote maintenance



Z1 ECO

Single work station suction system

The ideal system for individual workstations and dust-generating equipment.

This modern suction system is characterized by high efficiency in dust collection and

at the same time low noise-level of the motor.

Z1 CAM

Suction system for milling machines

The Z1 CAM represents the ideal device for removing fine dust from milling machines with low to medium usage intensity. The geometry of the filter case ensures a high filling level of the filter bag while maintaining the selected suction power.

Z1 ECO PRO/ Z1 CAM PRO

Single work station suction unit

- With innovative Smart-Drive control for carbon brush motors
- Permanent filter system for high dust generation
- Sound level in operation from 41dB(A) to 64dB(A)
- Online / Offline cleaning of filters
- Tool-free change of filter and motor
- Integrated Bluetooth module and Zubler Suction Technology App for individual settings, service and remote maintenance

Z1 ECO PRO

Single work station suction system

This system was developed for individual workstations and dust-generating devices with very high dust levels. Its motor impresses with high running stability and low noise even during intensive use.

Z1 CAM PRO

Suction system for milling machines

The suction system for milling machines with long working intervals and high dust generation. The use of two independent filter systems enables their dedusting during long working cycles without reducing the suction power.

Z1 - AT

Single work station suction unit

- With innovative Smart-Drive control for carbon brush motors
- External control element for managing the system directly at the working area (optional)
- Sound level in operation from 43dB(A) to 58dB(A)
- Integrated Bluetooth module and Zubler Suction Technology App for individual settings, service and remote maintenance



Replacement unit for suction units
A82 / A84 / A84-S / A84-SR & AT



Technical Data

Dimensions:

	Z1				Z1-AT
					Motorunit
Width:	200 mm				290 mm
Height:	675 mm				185 mm
Depth:	590 mm				385 mm

	ECO	CAM	ECO PRO	CAM PRO	
Weight:	28 kg	28 kg	31 kg	31 kg	18 kg
Power input:					
suction unit	750W	1000 W	750W	1000 W	750W
autom. socket	1200 W	-	1200W	-	1200W
Suction power:	15 - 50 l/s	15 - 65 l/s	15 - 50 l/s	15 - 65 l/s	15-40 l/s
Noise level:	41-57 dB(A)	41-65 dB(A)	54 - 63 dB(A)	54 - 66 dB(A)	45-58 dB(A)

FZ1 VARIOmaster®

2-Station-unit

Good reasons for an FZ1

- Low noise and low maintenance (thanks to a brushless vacuum motor offering bypass air cooling and sophisticated acoustic isolation of the exhaust stream).
- Permanent filter with automatic filter cleaning system. No filter bags.
- Separately exchangeable and inexpensive filter cartridges for particle separation and fine filtration.
- High-performance vacuum for use with belt sanders and sandblasters.
- Can be expanded via external position openers to accommodate up to four alternatively used vacuum positions.
- More room at the workspace.
- Comes ready with an exhaust connection, but recirculation is also an option.
- High-grade components and modular design for long service life and easy maintenance.



Vibration cleaned filter cartridge

How well a vacuum system performs will depend on the quality of the filter material and on the efficiency of the cleaning function of the filter. In addition to the brushless vacuum motor, the **FZ1 VARIOmaster®** utilizes a highly sophisticated filter technology.

The filters are arranged such that they can vibrate freely inside the housing. High-grade vibration equipment creates extremely powerful vibration, thus ensuring that dust layers are eliminated from the filter surface time after time.



▲ FZ1 VARIOmaster®

FZ1 VARIOmaster® is suitable for universal use in laboratories and workshops. A highly flexible concept allows for connection of four vacuum positions, to be controlled through individual modules. Vacuum positions are supplied as requested by the customer. This robust and high-performance suction unit is equally well suited for workspaces and for high-dust laboratory equipment. Laboratories in dental offices, or small-sized dental laboratories including only one or two technicians, may be able to cover their needs for device or workspace suction with a single **FZ1 VARIOmaster®** unit. Particularly comfortable is its alternative mode of operation, which allows different vacuum power levels to be defined for each position connected. The VARIO control system is simultaneously active, maintaining a constant air volume at all times, regardless of the condition of the filter.

Automatic vacuum port openers

AP501 modules will allow the **FZ1 VARIOmaster®** to be configured for up to 4 vacuum positions. Each AP501 offers connectivity for any universal controllers or laboratory equipment with up to 1000 W of power consumption. Its electronic control offers sensitivity adjustment to match

the connected (dust-generating) equipment, switches the vacuum position valve, and connects to the suction unit via a control cable.

Both the valve and the control unit are always located at the workspace. This makes installation very easy and transparent. Several vacuum positions can be connected to the same pipeline.

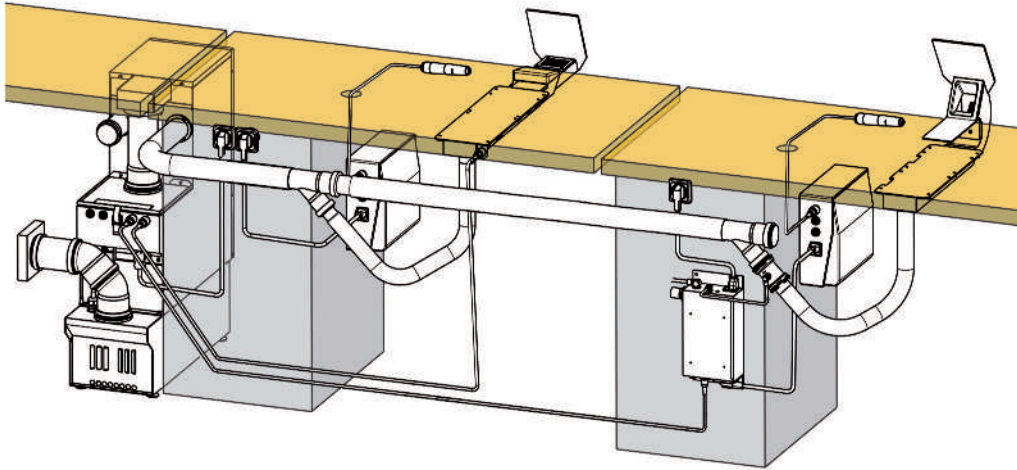

Dust container (No filter bags)

The high performance of this filter system comes into its own in very high-dirt areas. The use of a long-lasting filter cartridge eliminates the need for filter bags, thus greatly reducing operating costs.

All dust coming from the connected vacuum positions is collected in a container, which is emptied as needed.

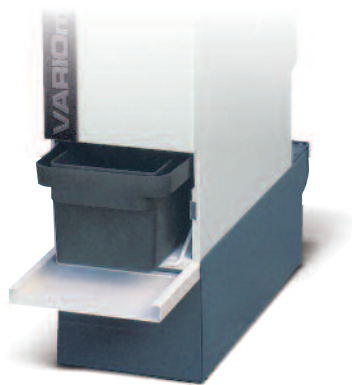

„VARIO“- the system with better motors

Brushless motors have a long service life. Greatly extended maintenance intervals will save you time and money.

The motor of the **FZ1 VARIOmaster®** is cooled by a ventilation circuit that bypasses (thus being separated from) the vacuum stream.

In this way, the motor is protected from overheating even during intake perturbations or filter overload.

Technical Data

FZ1 VARIOmaster®

Dimensions (Width x Height x Depth):	224 x 760 x 600 mm
Weight:	38 kg
Power input:	max. 1100 W
Motor:	brushless
Suction power:	approx. 60 l/s
Dust container volume:	5 l
Filter quality:	Dust class M
Filter surface:	1,5 m ²

FZ2 VARIOmatic®

4-Station-unit

Good reasons for an FZ2

- Two vacuum turbines (three-phase AC) for low noise and low maintenance. No brushes.
- Permanent filter with automatic filter cleaning system. No filter bags.
- Pneumatic filter reverse flow for high-performance suction of major dust loads.
- Can be expanded via external position openers to accommodate up to six vacuum positions.
- More room at the workspace.
- Exhaust installation for a better indoor climate.



▲ FZ2 VARIOmatic®



This unit was designed specifically for use in small dental laboratories. It offers a particularly reliable and clean vacuum solution even for high-dust preparatory workspaces and for functional equipment such as belt sanders. Office laboratories or small-sized regular laboratories may be able to cover all requirements for device or workspace suction by installing a single **FZ2 VARIOmatic®** as a mini-central.

When a handpiece or other connected tool is activated, each single vacuum position opens automatically (and regardless of any other positions connected). Once the tool is deactivated, it will close with a short delay to eliminate any residual dust (delayed-stop function).

FZ2 VARIOmatic® is continuously on standby, building up vacuum outputs as required without delay. Control of the vacuum turbines will automatically adjust to the number of open vacuum positions.



FZ2 VARIOmatic® Dentallab Engelhardt + Schnierer - Ulm/Germany ▲

Correct planning of vacuum installation

FZ2 VARIOmatic® will integrate with any furniture line. Matching front panels are mounted on request. Zubler will be happy to advise you and support your planning. Our experience will help you to find the correct vacuum solution for your laboratory.

Installation and maintenance will be greatly facilitated if the connections of the vacuum system are well accessible. Exhaust air should take the shortest path to the outside. Taking advantage of these options will greatly improve your lab environment and reduce noise even further.

Expansion modules

FZ2 VARIOmatic® can even be installed to cover 5 or 6 vacuum positions if AP500-D, AP501 or FP1000-D modules are additionally used. AP500-D and AP501 will connect to universal controllers, offering electronics with sensitivity adjustment. FP1000-D will connect to laboratory devices with up to 1000 W of power consumption.

The exhaust air from the **FZ2 VARIOmatic®** must be conveyed to the outside of the building. The entire stream of exhaust air is blasted outside through a piping connection 75 mm in diameter, which can be linked up with commercially available HT pipes.

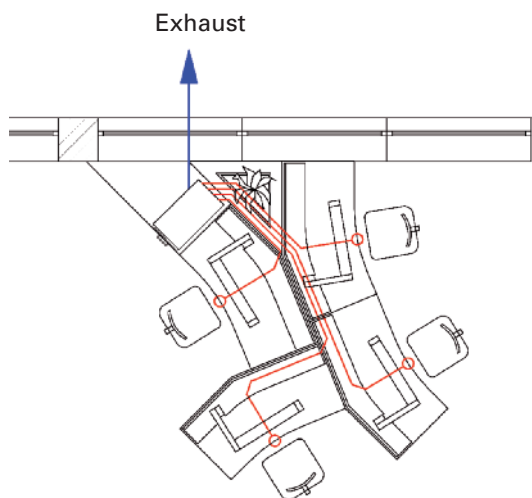

- ▶ The optimal solution is the standard variation shown by the connections of the **FZ2 VARIOmatic®** to 4 hand nozzle working positions close to each other. All working positions can be easily and quickly connected with a $\varnothing = 40$ mm hose. The vacuum system is easily reached from the back side for maintenance through the free area at the base and the free area under the flower pot.

The **FZ2 VARIOmatic®** is especially suitable for use where a very high amount of dust is produced, e.g. in an instrument room. Another unit (i.e. a fifth vacuum position) can be connected externally through an electronic switchbox with an additional valve. Pipes rather than individual flexible tubes should be installed if longish distances need to be covered.

Installations of this type are slightly more complex. At the same time, they result in a more compact system that is cleaner and offers better flow efficiency. In this example, the only direct connection via a flexible tube was established for the nearby sandblaster.

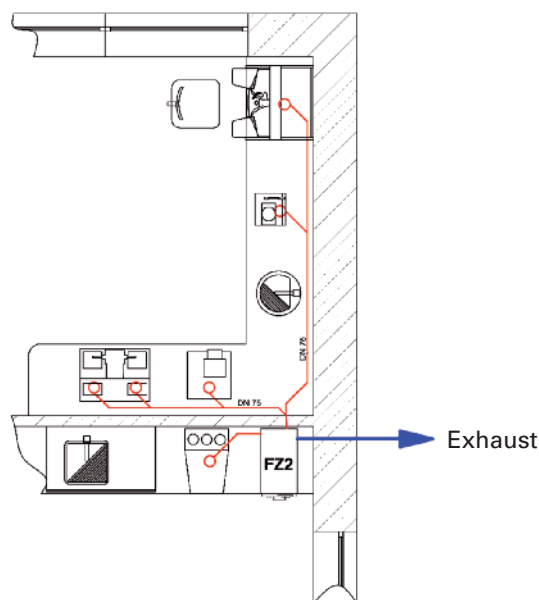

▶

▶

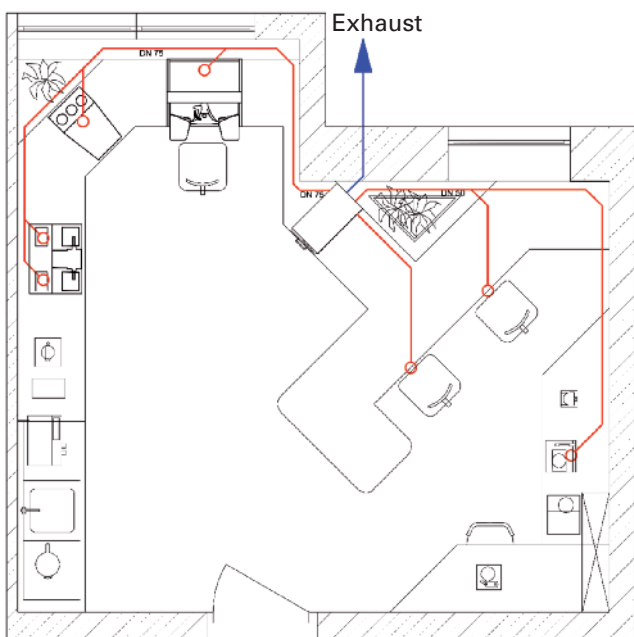

The **FZ2 VARIOmatic®** can, in some cases, e.g. in Practices and small laboratories, cover the entire requirement for vacuum positions. If some working positions are alternatively used, the connection of up to 6 vacuum positions is possible. All of the dirt from the laboratory would be collected in one container. Blowing the exhaust to the outside gives an optimal solution concerning noise, air quality, room climate and economy.

This example shows another situation in which a shared pipeline for all vacuum positions would be appropriate.

Addressing problems at their roots

Collectorless motors have a long service life. Zubler offer a three-year warranty. Other advantages of these motors include:

- No need to replace brushes.
- No carbon dust in the exhaust air.
- Operation with less noise and vibration.



Implementing motors of this type is a complex task, but the returns become noticeable very quickly in vacuum systems used as a centre for several positions.

FZ2 VARIOmatic® is equipped with two brushless motors.



Air performance and power consumption: filter technology rules

How well a vacuum system performs will depend on the size and quality of the filter material and on the efficiency of the cleaning function of the filter. Much of the filter technology used in competing products leaves something to be desired. **FZ2 VARIOmatic®**, by contrast, has been supplied with a filter cartridge encompassing a very large filter area (2.3 m²). This feature will ensure a high degree of air permeability.

Dusts are retained in the fine mesh structure of the filter material. The system features a pneumatic reverse flow, which will ensure that this mesh is continuously blasted clean.



FZ2 VARIOmatic® ▲
Filter cartridge

Effective filter equipment does have a footprint

Suction units should preferably be powerful, quiet and small. However, these are conflicting qualities. The filter surface needed for high air performance will occupy considerable space. High-performance blowers are either bulky, or they operate at high speed. In other words, smaller blowers are noisier. Good acoustic isolation can only work if certain surface and volume requirements are met.

We have delivered what is technologically feasible. Given your understanding that vacuum equipment does take space, you will find an appropriate solution that is powerful and will keep you comfortable in the long run. We put our money where our mouth is!

Technical Data

FZ2 VARIOmatic®

Dimensions (Width x Height x Depth):	334 x 810 x 600 mm
Weight:	72 kg
Power input:	suction unit: 1900 W
	autom. sockets: 4x 450 W
Motor:	brushless 2 pcs.
Suction power:	approx. 80 l/s
Dust container volume:	12 l
Filter surface:	2,3 m ²
Necessary pressure:	min. 5 bar

FZ VARIO

Central suction system



The **FZ VARIO** central vacuum system with its accessory intake funnels is a solution without compromise. With its efficient vacuum motors and filtration systems, available in different output classes and combinations, the Zubler central vacuum systems are suitable for providing suction at all dedicated workspaces for handpiece or resin processing, or indeed for any dust-producing devices, in dental laboratories of any size. The advantages of a central vacuum system become particularly obvious when all dust-generating devices and workspaces in the laboratory benefit from central suction. Devices with internal blower motors can be retrofitted for connectivity to the central vacuum system.

The VARIO system controls the air volume stream, continuously adapting the suction depending on the number of open vacuum positions. Compensation for filter pollution is also offered. The filter system will perform autocleaning at defined intervals, such that a high level of air permeability is sustained continuously. The motor seldom reaches its full speed and only does so briefly. These features will ensure a long service life and keep maintenance requirements very low. Laboratories using the **FZ VARIO** will observe all pertinent German regulations (German Federation of Commercial and Industrial Compensation Societies, Trade Supervisory Authority).

Good reasons for a "center"

- **Improved air quality**
 - Exhaust air is conveyed to the outside, which is very beneficial for the indoor climate.
 - When resins are processed, all toxic and unpleasant vapours are eliminated, and the working environment is cleared of residual/microscopic dusts.
 - Air change is promoted.
- **Less noise**
 - No vacuum motor around the workspace.
- **More space**
 - As no suction units and filter housings are located around the workspace, the technician has more space for tools/instruments and more freedom of movement.
- **Greater cleanliness**
 - No exchanging of filters in the laboratory, and dust is evacuated through the pipeline to the vacuum unit.
 - Cleaning of the laboratory is made easier by preinstalled vacuum outlets.
- **Smaller overhead**
 - High-efficiency large blower motors for lower energy consumption.

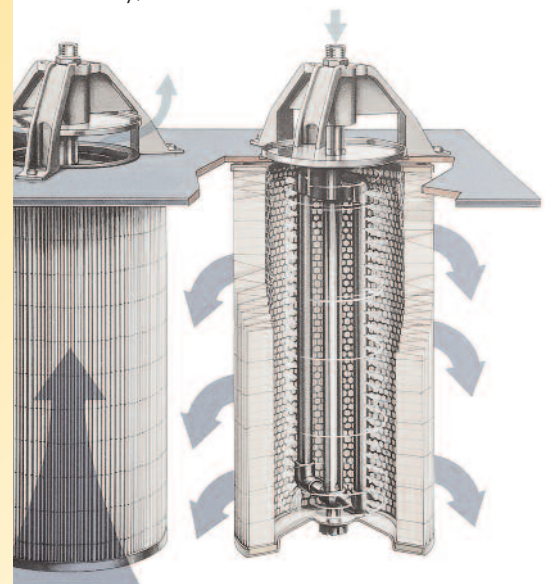

Vacuum equipment



Automatic vacuum port openers

Automatic vacuum position openers are standard features of any Zubler central vacuum system. They contribute significantly to the economical operation of the system, since the vacuum will be provided to the workspace only while dust is actually being generated. When a handpiece or other connected tool is activated (e.g. a sandblaster), the vacuum position opens automatical-

ly. Once the tool is deactivated, it will close with a short delay to eliminate any residual dust (delayed-stop function).

This process of automatically linking the dust-generating device to the electronic control of the vacuum position opener will ensure that your health is protected and that pertinent legal requirements for occupational safety and health are met (e.g. Germany).

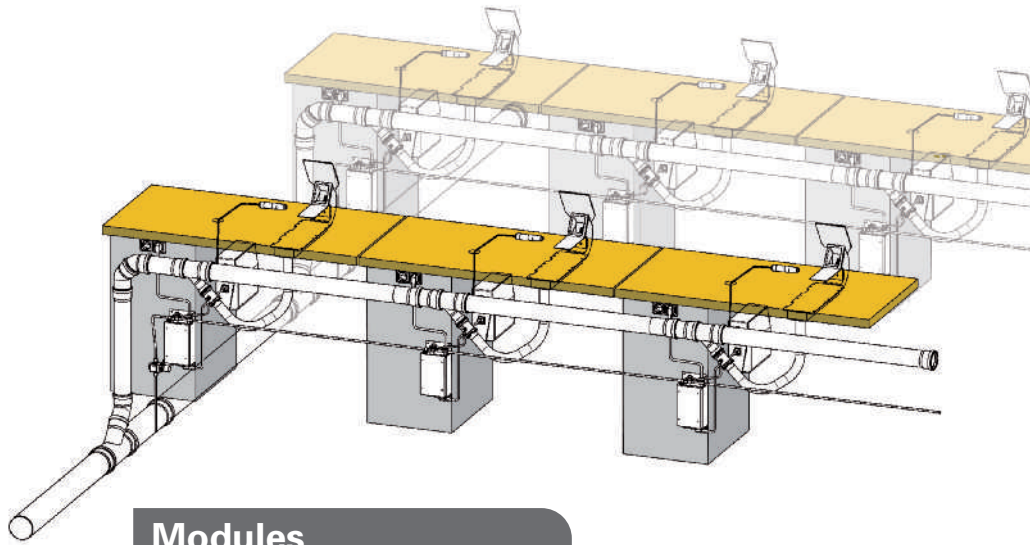

Modules

AP 500

AP500 is a vacuum position opener for all common universal controllers. Its response sensitivity can be automatically calibrated or manually adjusted. Being suitable for any laboratory devices up to 1000 W, this unit is the most flexible and high-grade controller for workspaces needing suction.

FP-D and FP 1000

FP-D is a vacuum position opener not featuring a delayed-stop function. It is designed for use with laboratory devices offering a direct-connection outlet.

FP1000 is a vacuum position featuring a delayed-stop function. It is designed for use with laboratory devices not accepting standby current and not featuring a vacuum outlet. This unit does not have suitable electronics for handpiece positions.

FP-M

FP-M is a vacuum position opener for manual activation. It can be used at workspaces where there is no electrical device capable of automatically opening the vacuum position, and which are exclusively designed for manual operation (e. g. mixing of monomer).

Special modules

Module F500 for Freuding

Special table inserts have been designed to match Freuding's F20 and F40 furniture lines. In addition to the electronic vacuum position opener, these inserts feature a pull-out suction canal with an integrated sound damper. Zubler's intake funnels R1200 and R1250 can be used with this system.

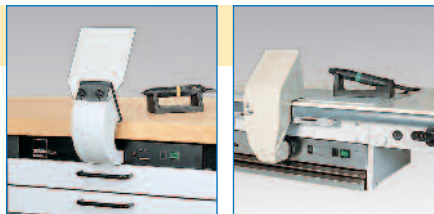

Module K500 for KaVo

With Ergospace furniture by KaVo, instead of using the vacuum drawer, the Zubler module is simply advanced into the existing support frame.

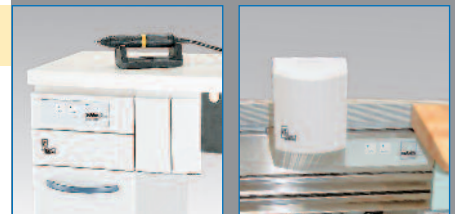

Custom-tailored solutions are also available for Masterspace and Flexspace workstations. Zubler's membrane keyboard is worked into KaVo's original panel.



Separation of dust types

Precious-metal dust should be collected as efficiently as possible in order to recover as much valuable material. The cost of precious metal recycling can be minimized by ensuring a high precious-metal

content of the recyclable material. The Zubler two-circuit technology™ uses a separate filtering system for all positions where the dust generated is likely to be (1) dust from a pure material such as dental stone,

acrylic or steel or (2) dust containing residual precious metal with only a low proportion of other dust. This requires installation of two separate pipe systems, which can be connected to the respective filtration system.

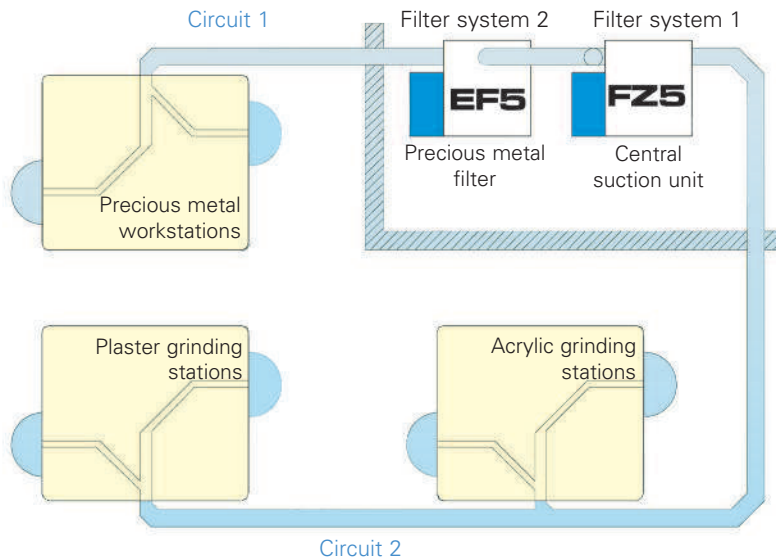

Separation of precious metals

- High-performance suction and effective health protection during precious-metal jobs.
- Superior performance to filter inserts in the intake funnel (which become rapidly clogged)
- Centralized detection of precious-metal dusts (independent of the technician's care and attention).
- Larger overall filter area for better performance of the vacuum system.
- Direct disposal of bulk dirt.
- Reduced separation costs.

Separation of sandblasting material

Sand particles inside the vacuum stream can become very destructive in the long run. They can reduce the wall thickness of tubes and pipes, especially at reduction fittings and elbows, sometimes even

creating holes. Sand particles should be filtered out directly where the sandblasting units are located, before they can enter the ducts of the vacuum systems. The S1 sandblasting separator is designed to accommodate up to three sandblasting units. The precipitated particles can be emptied into a simple bucket at regular intervals for disposal.





CAD



Detailed planning is required to install a central vacuum system. This is the only way to provide each workspace with an adequate and uniform stream of air, regardless of how many vacuum positions are open at a time and irrespective of their distance from the central vacuum unit. It might be helpful to call for an appointment, so our vacuum experts can visit your laboratory facilities to find out about important requirements and solutions.

Requirements



- **You are reassured**
 - about the health and environmental advantages that can only be attained with central vacuum system.
 - about the high performance and safe operation of Zubler's central vacuum system.
- **You have the facilities**
 - to accommodate the central unit in a separate room (e.g. a basement) or to create an appropriate installation site.
- **You have reached a decision**
 - whether you need separation of dust types (dirt vs. precious metal) or whether such separation is useful given your laboratory structure.

Ask for our questionnaire if you feel these requirements are met. Complete the questionnaire and return it to us. We also need a floor plan of your existing or projected laboratory. Talk to your architect or furnisher if they can supply a computerized plan in DXF format.

Appropriate solutions for any laboratory

It is always possible to install a central vacuum system, whether the laboratory is newly constructed or subjected to alterations, redevelopment or retrofitting. Professional

and clean execution of each installation is integral to Zubler's central vacuum technology. There is nothing to hide about our equipment. However, it is both an objective and

a challenge to hide it nevertheless, since our true focus is not on equipment but on offering an efficient and comfortable working environment.

Dental Lab Haasler Langenlois/A, 15 vac. ports

■ **Laboratory redevelopment**

- Vacuum pipe inside floor plate/pavement.
- Ideal routing of air streams, with the pipes taking the shortest path directly to the main connections. There is no need for paneling, as none of the pipe surfaces are visible.
- Installation is easier during laboratory construction or redesign.



Dental Lab Müller Dettingen, 25 vac. ports

■ **Laboratory construction**

- Vacuum pipes inside the floor plate (installation type offering numerous advantages).
- Configuration of workspaces as table islands.
- Requires exact planning. All installation details must be settled from the very outset of the construction works. Table groups may have to be aligned with existing floor connections.



Vacuum equipment

 **zubler**

Dental Lab Sobeck Lindau, 35 vac. ports

■ Laboratory redesign

- All vacuum positions integrated with furniture connected to the wall.
- "Ring circuit" concealed inside the window parapet, underneath benchtops, behind closets in the base.
- Pipe system is readily accessible and expandable.
- More complex installation, planning of extended and angulated ducts.



University of Zürich Switzerland, 150 vac. ports

■ Laboratory construction

- "Double floor" approach to installation.
- Pipe system remains accessible for subsequent expansion and structural changes.
- Pipe system involving extraordinary structural requirements, since this is a school installation that needs to withstand all vacuum positions being opened at exactly the same time, which takes extra planning and dimensions.



AV1000

Preparation station

For work preparation and especially dust-intensive work

- **Clean**
Excellent dust protection via optimal placement of suction funnel, compressed air nozzle for control blowing and grinding position
- **Ergonomic**
Large entry openings and special shaping of the arm rests allow a comfortable working position
- **Comfortable**
Automatic vacuuming of all dust, also during controlled compressed air
- **Clearly arranged**
Optimal placement of funnel, arm rests and protection glass shield provide a perfect field of view without reflection
- **Universal**
Connection to all vacuum systems is possible



What is especially important for a work preparation station ?

- Complete collection of all dusts
- Collection of almost all parts which may splinter off during grinding
- Automatic vacuuming also during blowing off the dust for controlling
- Simple disposal of large pieces which may occur
- Ergonomic construction and placement of support and contact surfaces
- Noise in the collection area is reduced to a minimum



Cleaning

Protection shield and working block can be swiveled up out of the way. The collection tub can be taken out and easily cleaned.

Lighting

The work preparation station is equipped standard with a 36 W Dulux energy saving bulb, giving light similar to daylight.

AV1000's practical and ergonomic design

A laboratory that strives for economic success in all its operations must keep a close eye on both quality and quantity. Usually this begins right in the preparatory stage for each process, where the foundation is laid for any top-quality work. This is why the design of the Zubler dust preparation box emphasizes ergonomics, cleanliness and efficiency.

Stone casts are blasted clean with compressed air by actuating the integrated blast nozzle with a footswitch. You do not need to take your hands off the cast or the micromotor is an enormous time saver in preparing stone casts.

The **AV1000** grinding box comes ready for connection to external vacuum systems.

AV 1000 Preparation station with base



Monomer box MB 1000

In the same design as the **AV1000** we also offer the Monomer station **MB 1000** to capture fumes produced when working with monomer materials. It is important to use a suitable extraction system with activated charcoal filter or a central suction system that vents waste air outside the laboratory.



Technical Data AV1000

Dimension (Width x Height x Depth):	630 x 430 x 580 mm
Weight:	26 kg
Necessary pressure:	min. 3 bar

Technical Data MB1000

Dimension (Width x Height x Depth):	630 x 430 x 420 mm
Weight :	18 kg

Accessories

To be able to use an economical and perfectly functioning suction system, it is important that all components harmonize with each other.

Therefore Zubler offers a wide range of accessories that have been created for the various applications in the dental industry.



▲ R1200 Vacuum funnel

Vacuum funnels R1200 + R1250

The plug-in vacuum funnel, R1200, is used with the fixed rectangular pipe R1000. It is quiet and equipped with a large safety shield.

The vacuum funnel R1250, with a small shield can be swiveled, has been designed for intricate work in

the ceramic and precious metal department.

The gold filter can simply be exchanged if needed. It is available as an option for the vacuum funnel R1250.



▲ R1250 Vacuum funnel with gold filter



Monomer bath R1600

By installing the monomer bath in a desk top, you obtain a comfortable stationary working place for mixing monomer and chemicals.

The mobile version R1601 can be used at different work stations by plugging it in the rectangular pipe R1000 (80 x 30 mm) instead of a vacuum funnel.

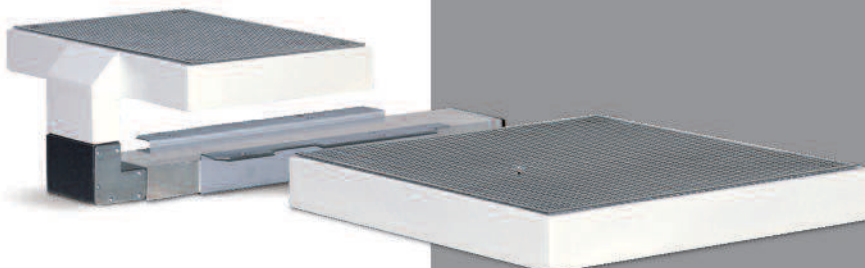

▲ R1601

▲ R1600

Vacuum hood R1500

Devesting and grinding creates an extreme amount of dangerous dust particles. The vacuum hood R1500, with flexible positioning arm, can be positioned according to the application.



▲ R1500

Suction hood SH-1

This suction funnel functions on every work bench without the need for permanent installation. The heavy base with a skid-proof, rubberized bottom can be used on the bench in every position.

The big safety glass shield protects the technician's eyes from injuries and is particularly effective in collecting dust right where it is produced (connection \varnothing 33 or 36 mm)



▲ SH-1 suction hood

R1500 Spray Box

The R1700 spray box was designed to draw away the particles from scan sprays prior to scanning.

Thanks to its unique design, the box allows the user to achieve optimal angle and movement, combined with an efficient suction power. The connection of the hose is available in 36 mm or 40 mm diameters.



Vacuum plug ST02

Vacuum plugs are placed in the laboratory areas where you choose. The floor and working area are quickly and easily cleaned with cleaning accessories.



Cleaning accessories

Zubler offers various cleaning sets as accessories. These are easily plugged into the vacuum plugs installed in the laboratory.



This allows easy cleaning of the area around the functional instruments.



Products for new standards

Vacuum equipment

Many years of experience and continuous development have put us in a position to offer a range of vacuum solutions that will ideally meet the needs of any laboratory. Our vacuum line ranges from single-position through multiple-position units up to central systems. Small, medium and large laboratories are covered. Zubler's expertise in dental technology has proved effective around the world. Countless vacuum applications have been implemented, including complex systems with over 100 vacuum positions in schools and universities. Numerous laboratories have benefited from this expertise and are enjoying better working conditions. Our vacuum systems are complemented by low-noise intake funnels and devices for highly effective dirt absorption. All elements combined make for a perfect overall system.

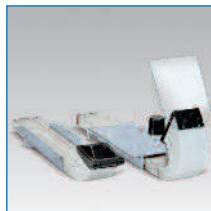

Dental Ceramic Furnaces

The furnace series VARIO 300 and VARIO 200 stand for precise and economical processing of modern dental ceramics. The combi-oven VARIO Press 300.ezr with its patented pressing technology for processing of lithium disilicate ceramics, especially shows, how dental expertise, engineering and industrial electronics from ZUBLER® can be combined in one device.

The generation of the firing furnace VARIO 200 series is based on proven technology and innovative expertise. The revolutionary design of the combustion chamber or the Z-Drying Mode are just an example of safe processing of dental ceramics with the highest quality standards.



Ceramay Dental Ceramics

As a subsidiary of ZUBLER® GmbH, CERAMAY® consolidates the reputation as progressive manufacturer of dental ceramics.

The pressing and layering ceramics Authentic™, DC Ceram™ 12.5 and DC Ceram™ 9.2, impress by simple handling and reproducibility of the result. The innovative clouding concept by means of nano-scatter centers in the ceramic base material ensures high color safety with different layer thicknesses and provides natural brightness and brilliance to the restoration, even under difficult lighting conditions.



Electronics

The controls and electronic assemblies of our devices come from own development and production. This advantage allows us to react directly to the changes in the market and offer the service to our customers to benefit of the latest improvements by installing updates.



technical changes without notice 1009/2019 en

Distribution:



www.zubler.de

B00092 / 02-2019



Zubler Gerätebau GmbH
Buchbrunnenweg 26
D-89081 Ulm-Jungingen
Tel. +49(0)731-14 52 0
Fax +49(0)731-14 52 13