



GERMAN  
DESIGN  
AWARD  
WINNER  
2019



 **WERK SITZ**

The specialists for workplace ergonomics

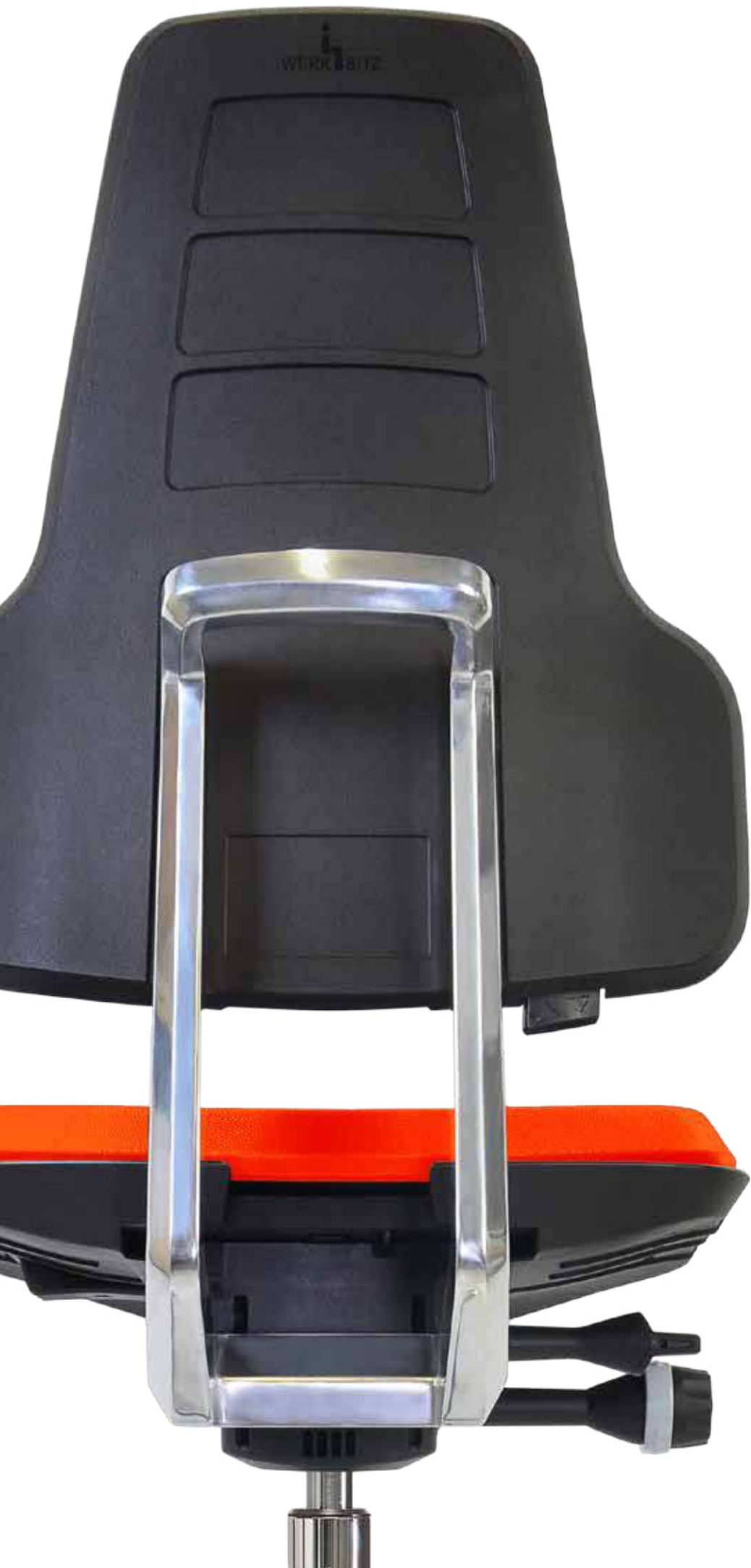

”

At **WERKSITZ**, we are committed to providing ergonomic workplaces, thereby making a significant contribution to health and productivity.

And we stand by this commitment

*The Milewski Family*

# TEAM SPIRIT AND FRANCONIAN FAMILY TRADITION – GUARANTEES FOR RELIABILITY AND LASTING VALUE.

As “the specialists for workplace ergonomics”, we have been committed to providing customers with optimum products for the workplace since 1980. Over the years, we have developed a comprehensive range of swivel chairs and workplace floor mats in standard and customised designs for industry, trade, laboratories and workshops for the disabled.

Our custom-tailored products offer contemporary solutions for more comfortable sitting and standing and meet all special ergonomic workplace requirements, thereby making a significant contribution to health and productivity.

We put special emphasis on quality products that are reliable, durable and backed by a long-term warranty. The modular design of our products offers maximum flexibility and investment security along with a spare part replacement guarantee for all of our components.

This is what we stand for as a sound Franconian family business. Take advantage of our no-obligation free trial to experience our quality for yourself.

The WERKSITZ TEAM



## OUR WARRANTY SERVICES AT A GLANCE

- ✓ **3-year warranty** on the Econoline series and the 7xxx chair series.
- ✓ **5-year warranty** on the WS 14xx wet room series
- ✓ **10-year warranty** on all other products. At ten years, this long-term warranty is one of the best offered in the industry.
- ✓ **10-year spare part replacement guarantee.**
- ✓ **Return guarantee:** At WERKSITZ, we take our responsibility to the environment seriously, which is why we manufacture our products in accordance with the strictest ecological principles.

Guarantee services are for standard industrial use of eight hours per day and 220 workdays per year. The warranty period is correspondingly shorter for multi-shift operations.

Guarantee services are covered by general warranty regulations and do not include vandalism or improper use.

WERKSITZ QUALITY-CHECK	
10-YEAR WARRANTY	✓
 DIN 68877	✓

**Exclusively from WERKSITZ**  
**2-year warranty extension**

You will receive a **2-YEAR WARRANTY EXPIRATION** according to a maintenance inspection. It is possible to extend this warranty for an additional two years as many times as you like!

## ON-SITE SUPPORT WORLDWIDE



The WERKSITZ dealer network with **over 40 branch offices** on four continents guarantees reliable customer service worldwide.

## SPECIALISTS FOR CUSTOMISED SOLUTIONS

We are the only supplier in the industry that offers customised solutions for every requirement. Talk to our competent, experienced employees today. We are

happy to design and build a custom chair for you and your application right in our own workshop. Guaranteed!





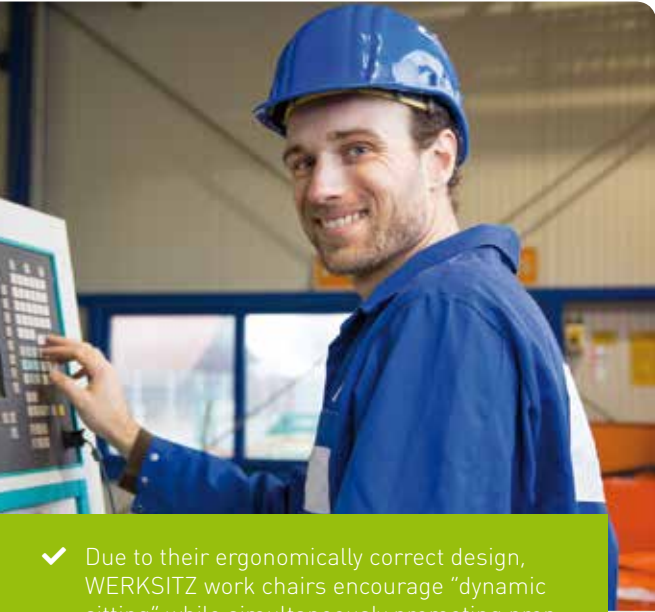

- ✓ Due to their ergonomically correct design, WERKSITZ work chairs encourage "dynamic sitting" while simultaneously promoting proper posture in every position.
- ✓ Ergonomically designed seats and backrests provide beneficial pressure distribution and pleasant climate comfort.
- ✓ We offer a variety of cushions and covers that can be precisely adapted to the conditions our chairs are used in.
- ✓ Numerous options including armrests, step-up rails, footrests, swivel locks and inflatable lumbar support pads complete our range of products.

### Your labour force is invaluable to you

The health of employees is a company's greatest asset. The "quality of sitting" has become an important health factor.

Different working areas demand intelligent work chair solutions. The ergonomic WERKSITZ concept promotes correct posture while seated and addresses the unique demands placed on a good work chair.

WERKSITZ effectively counteracts back pain with its ergonomic work chair concept and ensures a healthy, comfortable sitting position at work.

“ We value ergonomic posture and rely on WERKSITZ chairs. A new DIN-compatible work chair costs less than one lost day of work due to back pain.

### Invest in the health of your employees and save money in the process



➔ Ergonomic work chairs from WERKSITZ counteract bad posture and help prevent its negative effects. They support the muscular system and are thus your most effective tool against excess physical stress.

➔ A good work chair pays for itself by significantly reducing the costs due to lost work time. **A single lost day of work costs more than an ergonomic chair!** But beyond preventing lost work time due to injury and illness, a good work chair also contributes to a worker's sense of well-being at work, promotes concentration and boosts performance.

## ERGONOMICS GUIDELINES

### 5 TIPS FOR HEALTHY, RELAXED SITTING

**1** Set the right seat height

**2** Adjust the backrest height properly

**3** Use the entire seat

**4** Set the right seat tilt

**5** Practise dynamic and active sitting

**i** For more information about the WERKSITZ "Do your part to stay fit!" ergonomics concept visit [werksitz.de/machmit](http://werksitz.de/machmit)

➔ People spend one third of their professional lives sitting on their work chairs. Anyone who performs strenuous or repetitive tasks in the workplace needs a chair that will provide them with proper support. WERKSITZ work chairs can be adapted to any working situation and provide excellent stability and support, yet they do not restrict freedom of movement.

➔ Frequently changing your posture while seated reduces one-sided, unhealthy strain on the muscles and the intervertebral discs. The spinal column assumes its natural S-shape and takes the strain off the intervertebral discs and the buttocks, which improves blood circulation and the supply of nutrients. This enables the intervertebral discs to regenerate while simultaneously boosting concentration and performance.

# SAFETY AND QUALITY



We are the “specialists for workplace ergonomics”, after all, so certified safety and quality are our top priorities.

This is why we develop all of our components in house. Our plant in Zeil am Main is your guarantee for quality.

To ensure that WERKSITZ products always work reliably, we subject them to an extensive range of tests before our work chairs leave the factory.

WERKSITZ work chairs meet the stringent DIN 68 877 occupational health and safety standards.

They also conform with the statutory provisions outlined in the German Workplace Ordinance, Article 25 of the Workplace Directives.

WERKSITZ chairs are manufactured in accordance with the certified DIN ISO 9001 quality management system. Our work chairs are tested by TÜV Rheinland and bear the GS certification mark.

Outstanding WERKSITZ quality with a 10-year warranty. \*)



# THE WERKSITZ MODULAR DESIGN CONCEPT

Our modular system provides almost unlimited options, all components are screwed on and attached to the chair. This ensures that all chair elements are easy to replace. So you can create your own personalised chair, which can be enhanced with a wide range of additional accessories.

We are also happy to manufacture customised solutions for you. Your WERKSITZ product comes with all of the advantages that have made our work chairs so popular: High quality paired with cutting edge research, technology and occupational health insight and expertise.

Design your own chair with our WebConfigurator: [www.werksitz.com/english/configurator](http://www.werksitz.com/english/configurator)



### 1. Backrests and covers

Armrests are available in a number of different designs and sizes. Choose from Soft PUR integral foam, synthetic leather, fabric or wood.

### 2. Seat bases

Choose from a variety of seat designs and materials including Soft PUR integral foam, synthetic leather, fabric or wood.

### 3. Seat supports

We developed these premium-quality seat supports ourselves. They feature a modular design along with easycare maintenance and repair.

### 4. Armrests

Armrests feature a variety of designs and materials such as Soft PUR integral foam, synthetic leather, fabric or wood. They can be assembled in fixed or height-adjustable formats or with a 3D multifunction (even on existing chairs).

### 5. Chair columns

Chair columns in different sizes with gas pressure springs are available in height-adjustable, chrome-plated or powder-coated (black) versions. They can also be fitted with a column cover on request.

### 6. Five-star bases

Our five-star bases are made of high-quality polished diecast aluminium.

### 7. Castors, glides and disc bases

Depending on the field of application, our work chairs can be fitted with castors, glides or disc bases.

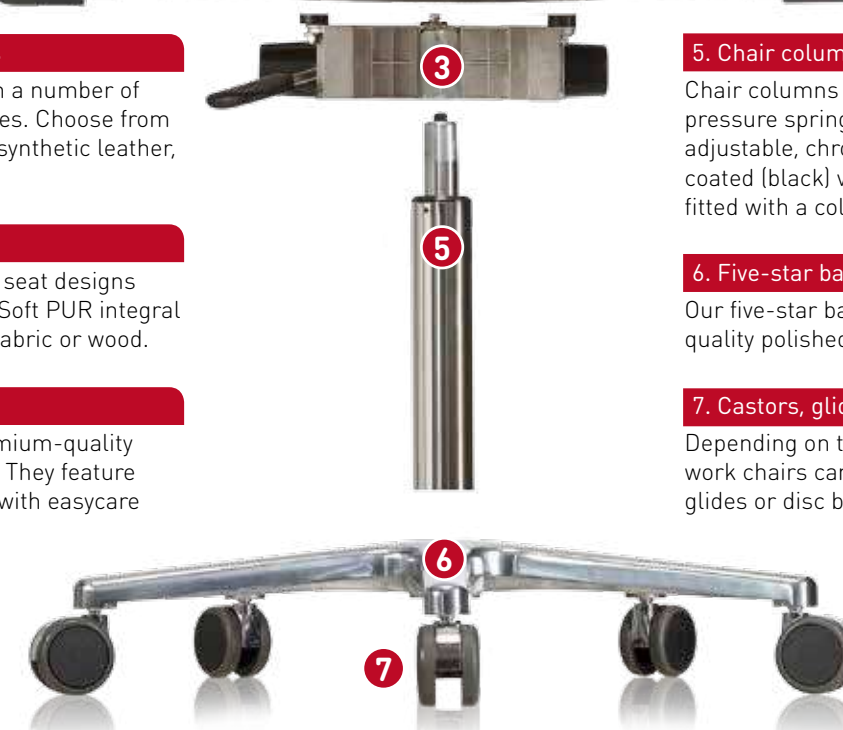

\*) if properly used in single-shift operation (excluding wear parts)



DISCOVER  
OUR VARIETY.



WERKSTAR The new premium series	12-21
WERKSITZ KLIMASTAR The premium work chair	22-31
WERKSITZ CLASSIC The versatile work chair	32-41
WERKSITZ ECONOLINE The rugged and economical work chair	42-47
WERKSITZ SPIDER/ NURSERY SCHOOL CHAIRS	48-49
INDUSTRY, PRODUCTION AND WORKSHOPS	50-59
ESD AREAS	60-61
LABORATORIES AND CLEAN ROOMS	62-69
WET ROOMS	70-73
PEOPLE WITH DISABILITIES	74-77
ACCESSORIES Customised upgrades and spare parts	78-80
SELECTION OF COLOURS AND FABRICS	81
ENVIRONMENTAL ASPECTS	82-83
WERKSTEP	84-89

# WERKSTAR

## THE NEW PREMIUM SERIES



FOR THE HIGHEST DEMANDS  
ON ERGONOMICS AND ELEGANCE

new

- ERGONOMIC
- USER FRIENDLY
- COMFORTABLE



WERKSTAR offers a comprehensive colour palette.

Imitation leather tiffany

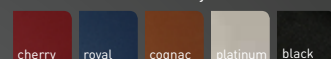

Imitation leather Black Amazona

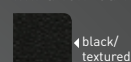

**NEW** NANOTEX fabric

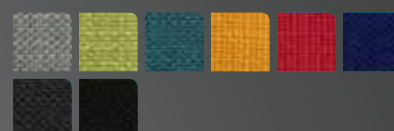

3D honeycomb fabric 2-colour



PUR foam



Additional colours available on request.

### Perfection in design

- Elegant and ergonomic design
- New seat cushion technology, breathable thanks to air circulation channels
- Cushions available in Soft PUR integral foam, fabric and imitation leather, with a large selection of colours



Acc. to DIN 68 877, a chair that can be adjusted to a height of more than 650 mm must be equipped with a step-up rail.

### Best possible ergonomics



Precision backrest contact pressure adjustment



Synchronously adjustable seat and backrest tilt



Separately adjustable three-stage seat tilt



Variable seat depth adjustment (up to 60 mm)



User friendly thanks to multifunctional hand wheel tension knob



Comfortable and safe thanks to anti-shock backrest system



Integrated lumbar support

### Technical specifications

Dimensions	Width in mm	Depth in mm
Seat: Soft PUR integral foam	465	460
Backrest: Soft PUR integral foam	210/440	500
Tilt	Forward	Back
Seat (tilt in 2.5° increments)	0°	+5°
Backrest (tilt in 5° increments)	-20°	0°

WERKSITZ QUALITY-CHECK

10-YEAR WARRANTY

Order a free trial - Try now for 14 days!

Order your desired model by phone, email or mail. We will send you the chair. Try it out in your workplace for 14 days. Then decide whether you wish to keep the chair or return it. It's that simple!





# WERKSITZ WERKSTAR

## SWIVEL CHAIR WITH CASTORS

**NEW**

Also available with **3D honey-comb fabric** in black/white or black/turquoise (see page 48 for example)



**WS 8220** signal red (RAL 3001)  
with **Soft PUR integral foam cushion**

- With adjustable backrest contact pressure
- Soft PUR integral foam backrest, (W top/bottom x H: 210/440 x 500 mm) backrest tilt: 0° to -20° (in 5° increments)
- Soft PUR integral foam seat with sliding seat mechanism, (W x D: 465 x 460 mm) seat tilt: 0° to +5° (in 2.5° increments) sliding range: 60 mm (in 10 mm increments)
- Height adjustment range: 485 to 635 mm
- Multifunctional lever for easy adjustment
- Polished five-star base (Ø 690 mm), with dual castors (Ø 65 mm)

**WS 8320** NANOTEX fabric black (Order no. 109022)  
with **fabric cushion**

- With adjustable backrest contact pressure
- Fabric upholstered backrest, (W top/bottom x H: 210/440 x 500 mm) backrest tilt: 0° to -20° (in 5° increments)
- Fabric upholstered seat with sliding seat mechanism, (W x D: 465 x 460 mm) seat tilt: 0° to +5° (in 2.5° increments) sliding range: 60 mm (in 10 mm increments)
- Height adjustment range: 485 to 635 mm
- Multifunctional lever for easy adjustment
- Polished five-star base (Ø 690 mm), with dual castors (Ø 65 mm)

**WS 8320 KL** tiffany cherry  
with **imitation leather cushion and armrests**

- With adjustable backrest contact pressure
- Imitation leather upholstered backrest, (W top/bottom x H: 210/440 x 500 mm) backrest tilt: 0° to -20° (in 5° increments)
- Imitation leather upholstered seat with sliding seat mechanism, (W x D: 465 x 460 mm) seat tilt: 0° to +5° (in 2.5° increments) sliding range: 60 mm (in 10 mm increments)
- Height adjustment range: 485 to 635 mm
- Multifunctional lever for easy adjustment
- Polished five-star base (Ø 690 mm), with dual castors (Ø 65 mm)
- With 4D\* multifunctional armrest

**WS 8311.20 KL** tiffany royal  
**High chair with imitation leather cushion and step-up rail**

- With adjustable backrest contact pressure
- Imitation leather upholstered backrest, (W top/bottom x H: 210/440 x 500 mm) backrest tilt: 0° to -20° (in 5° increments)
- Imitation leather upholstered seat with sliding seat mechanism, (W x D: 465 x 460 mm) seat tilt: 0° to +5° (in 2.5° increments) sliding range: 60 mm (in 10 mm increments)
- Height adjustment range: 725 to 940 mm
- Multifunctional lever for easy adjustment
- Polished five-star base (Ø 713 mm with sit-stop castors (Ø 65 mm), without load = braked/with load = locked)
- Step-up rail -06.80\*

ⓘ Acc. to **DIN 68 877**, a chair that can be adjusted to a height of **more than 650 mm** must be equipped with a **step-up rail**.

 Find an overview of the materials and colours we use on page 81.



# WERKSITZ WERKSTAR

## SWIVEL CHAIR WITH GLIDES



**NEW**  
Also available with **3D honey-comb fabric** in black/white or black/turquoise (see page 48 for example)



**WS 8210** black (RAL 9005)  
with **Soft PUR integral foam cushion**

- With adjustable backrest contact pressure
- Soft PUR integral foam backrest, (W top/bottom x H: 210/440 x 500 mm) backrest tilt: 0° to -20° (in 5° increments)
- Soft PUR integral foam seat with sliding seat mechanism, (W x D: 465 x 460 mm) seat tilt: 0° to +5° (in 2.5° increments) sliding range: 60 mm (in 10 mm increments)
- Height adjustment range: 465 to 620 mm
- Multifunctional lever for easy adjustment
- Polished five-star base (Ø 690 mm), with glides



**WS 8310** NANOTEX fabric red (Order no. 104000)  
with **fabric cushion and armrests\***

- With adjustable backrest contact pressure
- Fabric upholstered backrest, (W top/bottom x H: 210/440 x 500 mm) backrest tilt: 0° to -20° (in 5° increments)
- Fabric upholstered seat with sliding seat mechanism, (W x D: 465 x 460 mm) seat tilt: 0° to +5° (in 2.5° increments) sliding range: 60 mm (in 10 mm increments)
- Height adjustment range: 465 to 620 mm
- Multifunctional lever for easy adjustment
- Polished five-star base (Ø 690 mm), with glides
- With 4D\* multifunctional armrest



Seat and backrest shell also available in light grey\*

**WS 8310 KL** tiffany platinum  
with **imitation leather cushion**

- With adjustable backrest contact pressure
- Imitation leather upholstered backrest, (W top/bottom x H: 210/440 x 500 mm) backrest tilt: 0° to -20° (in 5° increments)
- Imitation leather upholstered seat with sliding seat mechanism, (W x D: 465 x 460 mm) seat tilt: 0° to +5° (in 2.5° increments) sliding range: 60 mm (in 10 mm increments)
- Height adjustment range: 465 to 620 mm
- Multifunctional lever for easy adjustment
- Polished five-star base (Ø 690 mm), with glides
- Seat and backrest shell light grey\*



**WS 8311 KL** tiffany black  
**High chair with imitation leather cushion and step-up rail\***

- With adjustable backrest contact pressure
- Imitation leather upholstered backrest, (W top/bottom x H: 210/440 x 500 mm) backrest tilt: 0° to -20° (in 5° increments)
- Imitation leather upholstered seat with sliding seat mechanism, (W x D: 465 x 460 mm) seat tilt: 0° to +5° (in 2.5° increments) sliding range: 60 mm (in 10 mm increments)
- Height adjustment range: 665 to 880 mm
- Multifunctional lever for easy adjustment
- Polished five-star base (Ø 690 mm), with glides
- With step-up rail -06.80\*

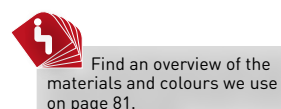

\* Accessories (see pages 19-20 and 78-81)

1 Acc. to **DIN 68 877**, a chair that can be adjusted to a height of **more than 650 mm** must be equipped with a **step-up rail**.

# WERKSITZ WERKSTAR

## SWIVEL CHAIR WITH DISC BASE



Seat and backrest shell also available in light grey\*



**WS 8210 T** light grey (RAL 7035)  
with Soft PUR integral foam cushion

- With adjustable backrest contact pressure
- Soft PUR integral foam backrest, (W top/bottom x H: 210/440 x 500 mm) backrest tilt: 0° to -20° (in 5° increments)
- Soft PUR integral foam seat with sliding seat mechanism, (W x D: 465 x 460 mm) seat tilt: 0° to +5° (in 2.5° increments) sliding range: 60 mm (in 10 mm increments)
- Height adjustment range: 470 to 615 mm
- Multifunctional lever for easy adjustment
- Chrome-plated disc base\* (Ø 420 mm)
- Seat and backrest shell light grey\*

**WS 8311 T** NANOTEX fabric blue (Order no. 109334)  
High chair with fabric cushion and step-up rail

- With adjustable backrest contact pressure
- Fabric upholstered backrest (W top/bottom x H: 210/440 x 500 mm) backrest tilt: 0° to -20° (in 5° increments)
- Fabric upholstered seat with sliding seat mechanism, (W x D: 465 x 460 mm) seat tilt: 0° to +5° (in 2.5° increments) sliding range: 60 mm (in 10 mm increments)
- Height adjustment range: 650 to 865 mm
- Multifunctional lever for easy adjustment
- Black disc base (Ø 550 mm)
- With step-up rail -06.80\*

Find an overview of the materials and colours we use on page 81.

## ACCESSORIES

### Armrests (in pairs)

**Armrest 1D 8xx**

1D multifunctional armrest, height adjustable by 100 mm.

**Armrest 2D 8xx**

2D multifunctional armrest, height adjustable by 100 mm, width adjustable by 2 x 38 mm.

**Armrest 3D 8xx**

3D multifunctional armrest with 30° swivel action, height adjustable by 100 mm.

**Armrest 4D 8xx**

3D multifunctional armrest with 30° swivel action, height adjustable by 100 mm, width adjustable by 2 x 38 mm.



### Foot rings

**Chrome-plated foot ring, Ø 440 mm**, with separate clamp and plastic bushing, infinitely variable height adjustment at the column. Order no.: **-05 K**

**Chrome-plated foot ring, Ø 540 mm**, with separate clamp and plastic bushing, infinitely variable height adjustment at the column. Order no.: **-05**



### Swivel lock

**Swivel lock**  
Order no.: **-0710.80**



### Step-up rails for high chairs

**Step-up rail**, tilt adjustable by 23°. Equipped with anti-slip footrest plate. The step-up rail can be folded upwards and follows the rotation and height adjustment of the chair. Height adjustment range: 60 mm. Order no.: **-06.80**



Additional accessories on the next page ▶

**!** Acc. to DIN 68 877, a chair that can be adjusted to a height of more than 650 mm must be equipped with a step-up rail.



## ACCESSORIES FOR HIGH CHAIR

### Step-up rails for high chairs

**Step-up rail**  
follows the rotation and height adjustment of the chair. Easy to install on existing chairs. Height adjustment range: 60 mm.  
Order no.: **-04.80**



### Swivel lock

**Swivel lock**  
Order no.: **-0711.80**



### Cover tube

**Cover tube, chrome-plated**



### Foot rings

**Chrome-plated foot ring, Ø 440 mm** with separate clamp and plastic bushing, infinitely variable height adjustment at the column.  
Order no.: **-05 K**



**Chrome-plated foot ring, Ø 540 mm** with separate clamp and plastic bushing, infinitely variable height adjustment at the column.  
Order no.: **-05**

### Special accessories

You will find additional accessories on [pages 78–80](#).

Naturally, we also offer custom solutions specially tailored to your needs and wishes.

**Combine** seat and backrest colours or materials. There are (virtually) no limits to the variety available here.

Visit our website at [www.werksitz.com](http://www.werksitz.com) or contact one of our experts.

Design your own chair with our [Web Configurator](#)

[www.werksitz.com/english/configurator](http://www.werksitz.com/english/configurator)



**WERKSITZ GRATIS-TEST**  
Einfach ein Musterexemplar bestellen und 14 Tage lang kostenlos testen!



# WERKSITZ KLIMASTAR – PERFECTION IN COMFORT AND ERGONOMICS

Optimum seat climate and comfort thanks to continuous air circulation. Ergonomic innovations promote healthy, dynamic sitting.



“ We do not want to sacrifice healthy posture while seated or a pleasant seat climate. This is why we chose the WERKSITZ Klimastar chair.



**WS 9220**  
 ■ with column cover\*  
 ■ with armrests -011 CH.90\*

WERKSITZ QUALITY-CHECK

10-YEAR WARRANTY

## KLIMASTAR – The premium work chair from WERKSITZ



### Ergonomic

- Adjustable height
- Large, tilt-adjustable seat
- High backrest:
  - Adjustable height
  - Supports the upper back
  - Relieves the spine
  - Protects the kidney area
- Precision backrest contact pressure adjustment
- Motion-synchronous pivot point shifting
- Ergonomically designed seat and back cushions

Our chairs offer plenty of room for healthy, dynamic sitting thanks to their ergonomic, tilt-adjustable seats and high backrests with individually adjustable contact pressure.

Ergonomic innovation featuring motion-synchronous pivot point shifting. This prevents the user's shirt from "riding up" as a result of an awkward reclining angle

### User friendly

- Functionally arranged adjusting elements
- Easy and intuitive operation

Seat positions can be adjusted easily, with just a few quick motions. Adjusting elements are functionally arranged and easy to use.

### Great climate

- Fully perforated seats and backrests
- Maximum air circulation
- Optimum seat climate

Fully perforated seats and backrests provide continuous air circulation and an optimum seat climate\*.

\* Studies conducted by the chair of ergonomics at the Technical University of Munich showed that perforated seats demonstrate significantly superior microclimatic properties (wet and dry heat transport) over seats without perforations. (Zeitschrift für Arbeitswissenschaft)

### Hygienic

- Removable cushions
- Easy to clean

Removable and interchangeable Soft PUR integral foam cushions ensure optimum occupational hygiene, especially in multishift operations.



Also available in an ESD model as an electrically conductive swivel chair for protection against electrostatic discharge in accordance with the EN 61340-5-1 standard.

## Technical specifications

Dimensions	Width in mm	Depth in mm
Seat: Soft PUR integral foam	470 front, 415 back	455
Backrest: Soft PUR integral foam	325 top, 400 bottom	450

Tilt	Forward	Back
Seat	-8°	+1°
Backrest	-18°	+11°

\* Accessories (see pages 25 and 78-81)



# WERKSITZ KLIMASTAR SWIVEL CHAIR WITH CASTORS



**WS 9220** black (RAL 9005)  
with **Soft PUR integral foamcushions**

- Soft PUR integral foam backrest and seat
- Chrome-plated armrests -011 CH.90\* with Soft PUR integral foam covers
- Chrome-plated column cover\*
- Height adjustment with safety gas spring (450-620mm)
- Polished diecast aluminium five-star base with load-dependent braking castors

**WS 9320 KL perforated** black  
with **breathable synthetic leather**

(also available in fabric or 3D honeycomb fabric)

- Perforated synthetic leather backrest and seat\*
- Black, hard plastic, height-adjustable armrests -010 H.90\*
- Chrome-plated column cover\*
- Height adjustment with safety gas spring (450-620mm)
- Polished diecast aluminium five-star base with load-dependent braking
- Perforated synthetic leather headrest\*

Find an overview of the materials and colours we use on page 81.

## ACCESSORIES

### Armrests (in pairs)

**Armrests** with Soft PUR integral foam covers (other colours available for an additional charge), chrome-plated tubing. Colours coordinated to match chair colour or another colour of choice.  
Order no.: **-010 CH.90**

**Armrests** with Soft PUR integral foam covers (other colours available for an additional charge), chrome-plated tubing. Colours coordinated to match chair colour or another colour of choice.  
Order no.: **-011 CH.90**

**Armrests** made of hard plastic, height adjustable, swivel-mounted, laterally adjustable, also optionally available with polished aluminium supports (-010 H.90 ALU).  
Order no.: **-010 H.90**

**Armrests** made of hard plastic, height adjustable by 70 mm.  
Order no.: **-011 H.90**



### Headrests

**Headrest** with 3D honeycomb fabric.  
Order no.: **-102 549**

**Headrest** with fabric.  
Order no.: **-102 571**

**Headrest** with synthetic leather.  
Order no.: **-102 685**



WERKSITZ QUALITY-CHECK	
10-YEAR WARRANTY	

### Foot rings

**Chrome-plated foot ring, Ø 440 mm**, with separate clamp and plastic bushing, infinitely variable height adjustment at the column.  
Order no.: **-05 K**

**Chrome-plated foot ring, Ø 540 mm**, with separate clamp and plastic bushing, infinitely variable height adjustment at the column.  
Order no.: **-05**



### Five-star base with castors and foot release

Effortless height adjustment and comfortable, contamination-free work while seated. Ideal for all chairs with castors, especially suited for laboratory and medical applications (seat height up to 640 mm).  
Order no.: **-079**



# WERKSITZ KLIMASTAR SWIVEL CHAIR WITH GLIDES



**WS 9210** distant blue (RAL 5023)  
with **Soft PUR integral foam cushions**

- Soft PUR integral foam backrest and seat
- Chrome-plated armrests -010 CH.90\* with Soft PUR integral foam covers
- Chrome-plated column cover\*
- Height adjustment with safety gas spring (430–600mm)
- Polished diecast aluminium five-star base, with glides



**WS 9310 KL perforated** light grey (no. 3102)  
with **breathable synthetic leather**  
(also available in fabric or 3D honeycomb fabric)

- Perforated synthetic leather backrest and seat
- Chrome-plated armrests -011 CH.90\* with Soft PUR integral foam covers
- Chrome-plated column cover\*
- Height adjustment with safety gas spring (430–600mm)
- Polished diecast aluminium five-star base, with glides

Find an overview of the materials and colours we use on page 81.

\* Accessories (see pages 25 and 78-81)

## ACCESSORIES

### Armrests (in pairs)

**Armrests** with Soft PUR integral foam covers (other colours available for an additional charge), chrome-plated column. Colours coordinated to match chair colour or another colour of choice.  
Order no.: **-010 CH.90**

**Armrests** with Soft PUR integral foam covers (other colours available for an additional charge), chrome-plated column. Colours coordinated to match chair colour or another colour of choice.  
Order no.: **-011 CH.90**

**Armrests** made of hard plastic, height adjustable, swivel-mounted, laterally adjustable, also optionally available with polished aluminium supports (-010 H.90 ALU).  
Order no.: **-010 H.90**

**Armrests** made of hard plastic, height adjustable by 70 mm.  
Order no.: **-011 H.90**



### Headrests

**Headrest** with 3D honeycomb fabric.  
Order no.: **-102 549**

**Headrest** with fabric.  
Order no.: **-102 571**

**Headrest** with synthetic leather.  
Order no.: **-102 685**



### Swivel lock

**Swivel lock**  
Order no.: **-0710.90**



### Foot rings

**Chrome-plated foot ring, Ø 440 mm**, with separate clamp and plastic bushing, infinitely variable height adjustment at the column.  
Order no.: **-05 K**

**Chrome-plated foot ring, Ø 540 mm**, with separate clamp and plastic bushing, infinitely variable height adjustment at the column.  
Order no.: **-05**



WERKSITZ QUALITY-CHECK	
10-YEAR WARRANTY	



# WERKSITZ KLIMASTAR HIGH CHAIRS



**WS 9211.20** ultramarine blue (RAL 5002)  
with **Soft PUR integral foam cushions**

- Soft PUR integral foam backrest and seat
- Chrome-plated armrests -011 CH.90\* with Soft PUR integral foam covers
- Step-up rail-06.90\*
- Chrome-plated column cover\*
- Height adjustment with safety gas spring (670-910mm)
- Polished diecast aluminium five-star base, with sit-stop castors



**WS 9311 3D** red (no. 3D07)  
with **breathable 3D honeycomb fabric**  
(also available in fabric or synthetic leather)

- 3D honeycomb fabric backrest and seat
- Chrome-plated armrests -010 CH.90\* with Soft PUR integral foam covers
- Step-up rail -04.90\*
- Chrome-plated column cover\*
- Height adjustment with safety gas spring (610-850mm)
- Polished diecast aluminium five-star base, with glides

Find an overview of the materials and colours we use on page 81.



**WS 9211 TPU** black (RAL 9005)  
with **Soft PUR integral foam cushions**

- Soft PUR integral foam backrest and seat
- Chrome-plated armrests -011 CH.90\* with Soft PUR integral foam covers
- Step-up rail -04.90\*
- Chrome-plated column cover\*
- Height adjustment with safety gas spring (630-870mm)
- Disc base in black (Ø 560 mm), with PUR moulded edge

## ACCESSORIES

### Armrests (in pairs)

**Armrests** with Soft PUR integral foam covers (other colours available for an additional charge), chrome-plated column. Colours coordinated to match chair colour or another colour of choice.  
Order no.: **-010 CH.90**



**Armrests** with Soft PUR integral foam covers (other colours available for an additional charge), chrome-plated column. Colours coordinated to match chair colour or another colour of choice.  
Order no.: **-011 CH.90**



**Armrests** made of hard plastic, height adjustable, swivel-mounted, laterally adjustable, also optionally available with polished aluminium supports (-010 H.90 ALU).  
Order no.: **-010 H.90**



**Armrests** made of hard plastic, height adjustable by 70 mm.  
Order no.: **-011 H.90**



Additional accessories on the next page ►

\* Accessories (see pages 25 and 78-81)

ⓘ Acc. to **DIN 68 877**, a chair that can be adjusted to a height of **more than 650 mm** must be equipped with a **step-up rail**.

## ACCESSORIES

### Step-up rails for high chairs

**Step-up rail** follows the rotation and height adjustment of the chair. Easy to install on existing chairs. Height adjustment range: 60 mm. Order no.: **-04.90**



### Step-up rails for high chairs

**Step-up rail**, tilt adjustable by 23°. Equipped with anti-slip footrest. The step-up rail can be folded upwards and follows the rotation and height adjustment of the chair. Height adjustment range: 60 mm. Order no.: **-06.90**



### Foot rings

**Chrome-plated foot ring, Ø 440 mm**, with separate clamp and plastic bushing, infinitely variable height adjustment at the column. Order no.: **-05 K**



**Chrome-plated foot ring, Ø 540 mm**, with separate clamp and plastic bushing, infinitely variable height adjustment at the column. Order no.: **-05**

### Swivel lock

**Swivel lock -0711.90**  
Order no.: **101918**



### Column cover

**Chrome-plated column cover**



### Special accessories

Find additional accessories on [pages 78-80](#).

We also offer special custom solutions according to your technical requirements.

**Combine** seat and backrest colours or materials. There are (almost) no limits to the available varieties.

Visit our website at [www.werksitz.com](http://www.werksitz.com) or contact our expert team.

Design your own chair with our [Web Configurator](#)

[www.werksitz.com/english/configurator](http://www.werksitz.com/english/configurator)



## GREAT CLIMATE WITH THE WERKSITZ KLIMASTAR

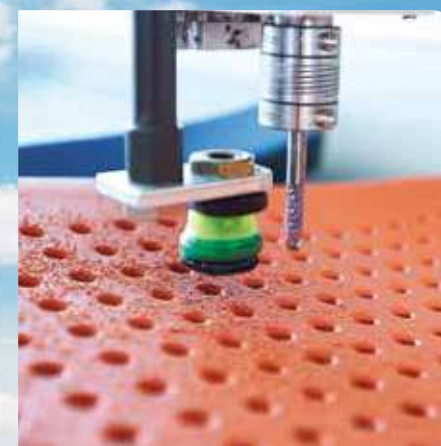



# WERKSITZ CLASSIC – FOR DAILY USE IN THE MOST DEMANDING APPLICATIONS

These ergonomically advanced swivel chairs offer versatility along with quality craftsmanship for everyday use.



### WS 1210 E

- Also available with five-star base with glides



“ Our customers are not the only ones with high standards. WERKSITZ chairs have the best image here. The sophisticated technology and the quality craftsmanship give us the assurance we need.



WERKSITZ QUALITY-CHECK

10-YEAR WARRANTY

### WS 1220 E

- with column cover\*

## CLASSIC – The versatile work chair from WERKSITZ



### Ergonomic

- Adjustable height
- Large, tilt-adjustable seat
- High backrest:
  - Adjustable height
  - Supports the upper back
  - Relieves the spine
  - Protects the kidney area
- Precision backrest contact pressure adjustment
- Motion-synchronous pivot point shifting
- Ergonomically designed seat and back cushions

Our chairs offer plenty of room for healthy, dynamic sitting thanks to their ergonomic, tilt-adjustable seats and high backrests with individually adjustable contact pressure.

Ergonomic innovation featuring motion-synchronous pivot point shifting. This prevents the user's shirt from "riding up" as a result of an awkward reclining angle.



### User friendly

- Functionally arranged adjusting elements
- Easy and intuitive operation

Seat positions can be adjusted easily, with just a few quick motions. Adjusting elements are functionally arranged and easy to use.

### Versatile



- Seat and backrest made of wood – an organic product featuring nature's perfect design



- Also available in synthetic leather or fabric designs



- Soft PUR integral foam with thermosensitive properties



- XL backrest, Soft PUR integral foam with thermosensitive properties

### Extremely Rugged



The extremely durable and rugged work chairs from WERKSITZ are manufactured using only the highest quality materials. They meet "GS-certified safety" standards and are made in Germany.



Also available in an ESD model as an electrically conductive swivel chair for protection against electrostatic discharge in accordance with the EN 61340-5-1 standard.

## Technical specifications

Dimensions	Width in mm	Depth in mm
Seat: Soft PUR integral foam	460	435
Backrest: Soft PUR integral foam	420	300

Tilt	Forward	Back
Seat	-4°	+10°
Backrest	-10°	+8°

\* Accessories [see pages 38-40 and 78-81]

# WERKSITZ CLASSIC

## SWIVEL CHAIR WITH CASTORS



**WS 1220 E XL** black (RAL 9005)  
with Soft PUR integral foam backrest and seat

- Soft PUR integral foam XL backrest and seat
- Hard plastic, height-adjustable armrests -011 H\*
- Chrome-plated column cover\*
- Height adjustment with safety gas spring (460–640mm)
- Polished diecast aluminium five-star base with load-dependent braking castors



**WS 1320 XL ERGO** cactus (no. 126/126)  
with fabric backrest and seat

- Fabric XL backrest and seat
- Hard plastic ring armrests -011 D\*
- Chrome-plated column cover\*
- Height adjustment with safety gas spring (460–640mm)
- Polished diecast aluminium five-star base with load-dependent braking castors



**WS 1020 XL**  
8-ply glued, moulded, natural varnished beechwood  
with wooden backrest and seat

- Wooden XL backrest and XL seat
- Armrests with wooden surfaces -010 CH\*
- Chrome-plated column cover\*
- Height adjustment with safety gas spring (440–620mm)
- Polished diecast aluminium five-star base with load-dependent braking castors



**WS 1320 KL Wave XL ERGO**  
black (no. 202) / fire red (no. 207x1173)  
with synthetic leather backrest and seat

- XL backrest and XL synthetic leather seat
- Hard plastic, height-adjustable armrests -010 H ALU\*
- Chrome-plated column cover\*
- Height adjustment with safety gas spring (460–640mm)
- Polished diecast aluminium five-star base with load-dependent braking
- With headrest\*

 Find an overview of the materials and colours we use on page 81.



## WERKSITZ CLASSIC SWIVEL CHAIR WITH GLIDES



### WS 1210 E black (RAL 9005) with Soft PUR integral foam backrest and seat

- Soft PUR integral foam backrest and seat
- Height adjustment with safety gas spring (450–630mm)
- Polished diecast aluminium five-star base with glides

### WS 1310 ERGO NANOTEX fabric lime green (Order no. 104006) with fabric backrest and seat

- Fabric Ergo backrest and seat
- Hard plastic -011 D\* safety armrests
- Height adjustment with safety gas spring (450–630mm)
- Polished diecast aluminium five-star base with glides

### WS 1010 8-ply glued, moulded, natural varnished beechwood with wooden backrest and seat

- Wooden backrest and seat
- Height adjustment with safety gas spring (420–600mm)
- Polished diecast aluminium five-star base with glides

### WS 1310 KL dark grey (no. 207x3120) with synthetic leather backrest and seat

- Synthetic leather backrest and seat
- Height adjustment with safety gas spring (450–630mm)
- Polished diecast aluminium five-star base with glides

## WERKSITZ CLASSIC HIGH CHAIRS



### WS 1211 E XL signal red (RAL 3001)\* with Soft PUR integral foam backrest and seat

- Soft PUR integral foam backrest and seat
- Step-up rail -04\*
- Height adjustment with safety gas spring (620–860mm)
- Polished diecast aluminium five-star base with glides

### WS 1311.20 ERGO NANOTEX fabric silver (Order no. 109102) with fabric backrest and seat

- Fabric Ergo backrest and seat
- Step-up rail -06\*
- Height adjustment with safety gas spring (680–920mm)
- Polished diecast aluminium five-star base with sit-stop castors

### WS 1011 XL T 8-ply glued, moulded, natural varnished beechwood with wooden backrest and seat

- Wooden XL backrest and XL seat
- Step-up rail -08\*
- Height adjustment with safety gas spring (610–850mm)
- disc base black (Ø 550 mm)

### WS 1311.20 KL ERGO turquoise (no. 208x797) with synthetic leather backrest and seat

- Synthetic leather Ergo backrest and seat
- Step-up rail -04\*
- Height adjustment with safety gas spring (680–920mm)
- Polished diecast aluminium five-star base with sit-stop castors

\* Accessories (see pages 38–40 and 78–81)

ⓘ Acc. to DIN 68 877, a chair that can be adjusted to a height of more than 650 mm must be equipped with a step-up rail.

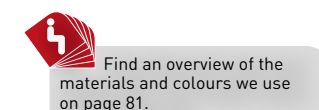

# THE CHOICE IS YOURS

## CLASSIC backrests are available in different sizes

### Soft PUR integral foam backrests

XL  
[310/440x450mm]



Standard  
[420x300mm]



### Wooden backrests

XL  
[315/385x430mm]



Standard  
[440x260mm]



Swivel chair with **thorax backrest** for use in **nursery schools**



### Fabric backrests

XL ERGO  
[230/400x445mm]



Ergo back rest [-014/13.2]  
[445x365mm]



Standard  
[440x270mm]



### Synthetic leather backrests

XL KL ERGO  
[230/400x445mm]



Ergo backrest [-014/13.2 KL]  
[445x365mm]



Standard KL  
[440x270mm]



## Some CLASSIC chairs are available in two sizes

### Soft PUR integral foam seat



Standard  
[460x435mm]



### Fabric seats

XL  
[430/460x445mm]



Standard  
[460x420mm]



### Wooden seats

XL  
[420/450x425mm]



Standard  
[450x400mm]



### Synthetic leather seats

XL  
[430/460x445mm]



Standard  
[460x420mm]



# ACCESSORIES

## Armrests (in pairs)

**Armrests** with wooden surfaces, chrome-plated column. Order no.: **-010 CH**



**Armrests** with Soft PUR integral foam covers powder-coated column. Colours coordinated to match chair colour or another colour of choice. Order no.: **-010 CH**



**Armrests** made of hard plastic, height adjustable, swivel-mounted, laterally adjustable, also optionally available with polished aluminium supports [-010 H ALU]. Order no.: **-010 H**



WERKSITZ QUALITY-CHECK

10-YEAR WARRANTY

Hard plastic **safety ring armrests**. Order no.: **-011**



Hard plastic **safety ring armrests** featuring a modern design. Order no.: **-011 D**



Hard plastic **safety armrests**, height-adjustable by 70 mm. Order no.: **-011 H**



**Safety armrests** with wooden surfaces, chrome-plated column. Order no.: **-012 CH**



## Headrests

**Headrest** with 3D honeycomb fabric. Order no.: **-101 697**



**Headrest** with fabric. Order no.: **-100 849**



**Headrest** with synthetic leather. Order no.: **-100 824**



## Special accessories

Find additional accessories on **pages 78-80**.

We also offer special custom solutions according to your technical requirements.

**Combine** seat and backrest colours or materials. There are (almost) no limits to the available varieties.

Visit our website at **www.werksitz.com** or contact our expert team.



Design your own chair with our Web Configurator: [www.werksitz.com/english/configurator](http://www.werksitz.com/english/configurator)



## ACCESSORIES

### Step-up rails for high chairs

#### Step-up rail

- Tilt adjustable by 23°
- With fold-up footrest plate
- Height adjustment range 60 mm
- Also available in ESD and GMP designs

Order no.: **-06**



#### Step-up rail

- Height adjustment range 60 mm
- Also available in ESD and GMP designs

Order no.: **-04**



#### Step-up rail

- Anti-slip design
- Also available in an ESD model

Order no.: **-08**



### Column cover

#### Chrome-plated column cover



All step-up rails follow the rotation and height adjustment of the chair.



### Foot rings

**Chrome-plated foot ring, Ø 440 mm,** with separate clamp and plastic bushing, infinitely variable height adjustment at the column.

Order no.: **-05 K**

**Chrome-plated foot ring, Ø 540 mm,** with separate clamp and plastic bushing, infinitely variable height adjustment at the column.

Order no.: **-05**



### Five-star base with castors and foot release

Effortless height adjustment and comfortable, contamination-free work while seated. Ideal for all chairs with castors, especially suited for laboratory and medical applications (seat height up to 640 mm)

Order no.: **-079**



### Swivel lock

#### Swivel lock

Order no.: **-0711**



## ULTIMATE COMFORT WITH WERKSITZ CLASSIC





# WERKSITZ ECONOLINE – A RUGGED WORK CHAIR FOR TOUGH WORK CONDITIONS

The economical chair concept: ECONOLINE, our affordable introductory model for healthy posture while seated.



Combining a healthy sitting posture for everyday work in tough conditions with ergonomics is far from simple when you are on a budget. But WERKSITZ did it for us with their ECONOLINE chairs.

WS 2220



■ Infinitely variable backrest adjustment



■ Adjustable seat tilt  
■ Dual castors with load-

## User friendly

- Seat height adjustment using a safety gas spring
- Infinitely variable backrest adjustment and adjustable seat tilt by using the lever
- Handy functional elements
- Tilt-safe five-star base made of highgrade, scratch and impact-resistant plastic
- Wear-resistant glides
- Dual castors with load-dependent braking
- Also available with sliding seat

The rugged, user-friendly work chair for everyday work in tough conditions.



dependent braking  
■ Handy functional elements



## Features

Rugged yet sophisticated features enable comfortable posture while seated. User-friendly operating elements make it easy for users to individually adapt their chairs to the desired seat position.

The work chair is designed for a wide range of uses and features a variety of materials, including wood, fabric, synthetic leather or Soft PUR integral foam.

The WERKSITZ modular system makes it possible to configure customised chairs with additional accessories.

## Economical

ECONOLINE is a chair concept developed according to the industry standard. It promotes a healthy, ergonomic sitting posture even under the toughest work conditions.



Also available with sliding seat, adjustment range: 6 cm

## Technical specifications

Dimensions	Width in mm	Depth in mm
Seat: Soft PUR integral foam	440	420
Backrest: Soft PUR integral foam	420	300

Tilt	Forward	Back
Seat	-14°	+5°
Backrest	-34°	+30°



# WERKSITZ ECONOLINE SWIVEL CHAIR

## ACCESSORIES



**WS 2211** distant blue (RAL 5023)\*  
**High chair with soft PUR integral foam backrest and seat**

- High chair
- Soft PUR integral foam backrest and seat
- Height adjustment with safety gas spring (650–860mm)
- Foot ring -05 Ergo\*
- Plastic five-star base with glides



**WS 2320 XL ERGO** fire red (no. 055/055)  
**Chair with castors and fabric backrest and seat**  
 (also available in imitation leather)

- Fabric seat and fabric XL ergo backrest
- Hard plastic armrests -011.20\*
- Height adjustment with safety gas spring (470–650mm)
- Plastic five-star base with load-dependent braking castors



**WS 2220 XL** light grey (RAL 7035)\*  
**Chair with castors with soft PUR integral foam backrest and seat**

- Seat and XL backrest
- Height adjustment with safety gas spring (470–650mm)
- Plastic five-star base with load-dependent braking castors
- Sliding seat mechanism\*

### Armrests (in pairs)

Hard plastic **ring armrests**.  
 Order no.: **-011.20**

Hard plastic **armrests**, height-adjustable, swivel-mounted, laterally adjustable.  
 Order no.: **-010 H.20**



### Sliding seat mechanism



Hard plastic **armrests**, height-adjustable by 70 mm.  
 Order no.: **-011 H.20**



### Foot ring

**Chrome-plated foot ring**, Ø 440 mm, with separate clamp.  
 Order no.: **-05 K Ergo**



Also available in wood design.

Find an overview of the materials and colours we use on page 81.

\* Accessories [see page 45 and 78-81]

\* Accessories [see page 45 and 78-81]

ⓘ Acc. to **DIN 68 877**, a chair that can be adjusted to a height of **more than 650 mm** must be equipped with a **step-up rail**.



# STANDS UP TO MOST CONDITIONS ... WERKSITZ ECONOLINE





# WERKSITZ SPIDER – THE ALTERNATIVE FOR OFFICE AND ADMINISTRATION

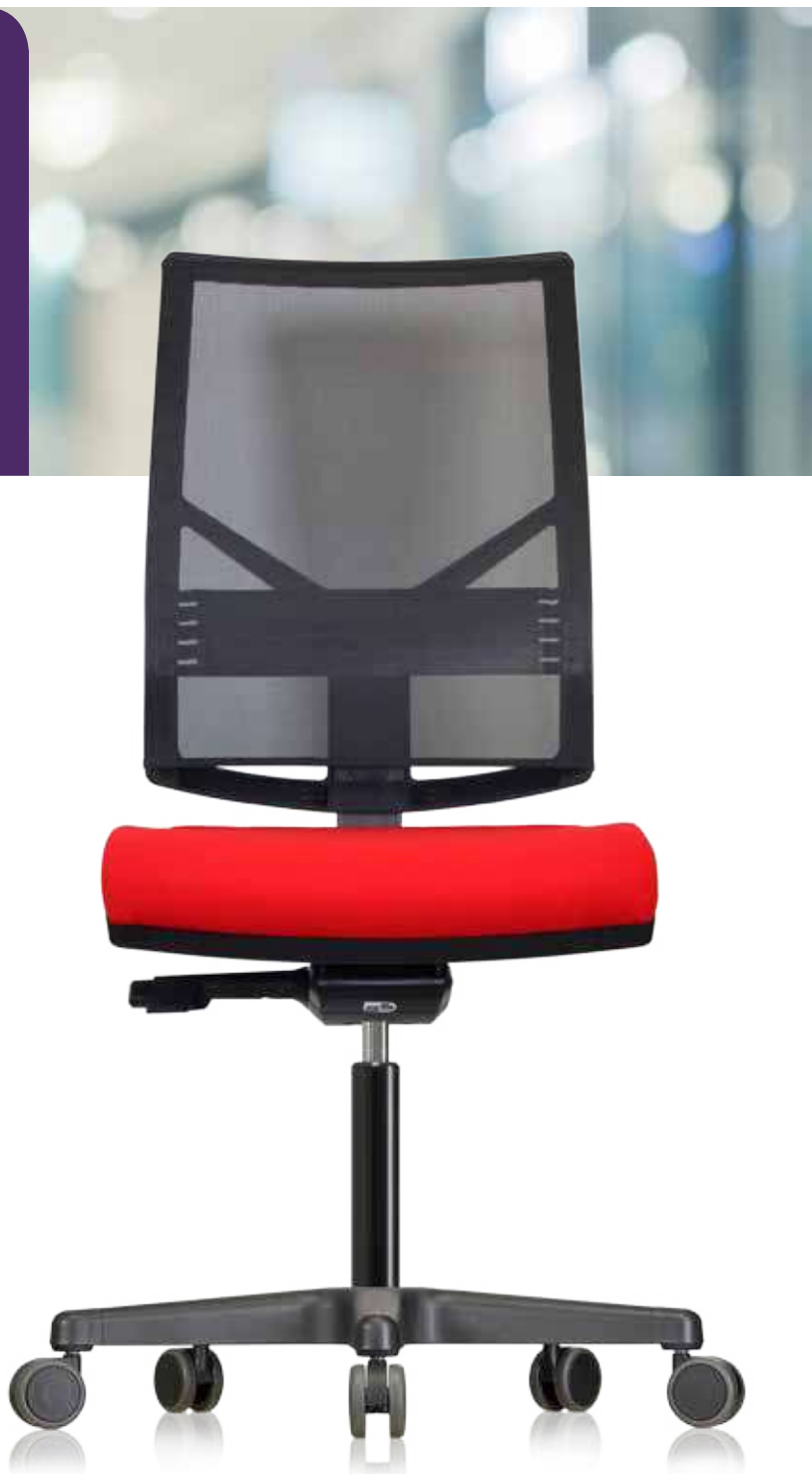

## WS 8920 SPIDER

black/red (055/055)

- XL mesh back  
W top/bottom x H: 440/460 x 600mm  
backrest tilt: -22° to +3°
- Integrated lumbar support
- Asynchronous mechanism with sliding seat function
- Fabric upholstered seat  
W back/front x D: 460/470 x 435mm  
seat tilt: 0° to 5°
- Height adjustment range: 450 to 630mm
- Plastic five-star base (Ø 630mm), with dual castors (Ø 65mm)



WERKSITZ QUALITY-CHECK

2-YEAR WARRANTY

### Spider headrest and armrests



■ Swivel headrest\*



■ 2D armrest, height and laterally adjustable\*

## AT EYE LEVEL WITH CHILDREN

WERKSITZ QUALITY-CHECK

10-YEAR WARRANTY



# NURSERY SCHOOL CHAIRS

Our chair programme for nursery schools



**WS 3020 PU Classic KiGa**  
Soft PUR integral foam seat (signal red RAL 3001)



The ergonomically designed **thorax backrest** ensures fatigue-free sitting.



**WS 1320 ERGO KiGa**  
Ergo fabric backrest (fire red 055/055)  
Fabric backrest (azure 034/034)



**WS 3320 KL V KiGa**  
Imitation leather (black 217x293 / fire red 207x1173)



**WS 1320 Thorax KiGa**  
Thorax backrest (azure 034/034) and fabric seat (fire red 055/055)



**WS 4520 KiGa**  
Imitation leather seat (turquoise 208x797)

# WORK CHAIRS FOR INDUSTRY, PRODUCTION AND WORKSHOPS

Healthy, dynamic sitting for well-being in the workplace – a business investment with lasting results.



Quality and reliability are the top priorities in our workshop. Investing in rugged work chairs from WERKSITZ was a good decision.



## WS 1211.20 E XL

- With step-up rail -06\*
- With sit-stop castors
- Polished diecast aluminium five-star base

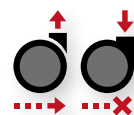

Also available in an ESD model as an electrically conductive swivel chair for protection against electrostatic discharge in accordance with the EN 61340-5-1 standard.



# WERKSITZ WORK CHAIRS AND STANDING SUPPORTS FOR INDUSTRY AND WORKSHOPS



Standing support also available with sit-stop dual castors or five-star base with glides

## WS 1210 E

black (RAL 9005)/signal red (RAL 3001)\*

### Work chair with foot ring

- Soft PUR integral foam backrest and seat
- Foot ring 05\*
- Height adjustment with safety gas spring (450–630mm)
- Polished diecast aluminium five-star base with glides

## WS 4211 T

black (RAL 9005)

### Standing support

- Soft PUR integral foam seat
- Height adjustment with safety gas spring (630–840 mm)
- Disc base in black



**WS 5020**  
Mobile parts trolley

\* Accessories [see pages 78-81]

1 Acc. to DIN 68 877, a chair that can be adjusted to a height of more than 650 mm must be equipped with a step-up rail.



## WERKSITZ WORK CHAIRS MADE OF WOOD



**WS 1011.20**  
8-ply glued, moulded, natural varnished beechwood  
**High chair with wooden backrest and seat**

- Wooden backrest and seat
- Step-up rail -06\*
- Height adjustment with safety gas spring (660–900mm)
- Polished diecast aluminium five-star base with sit-stop castors



**WS 1011 XL**  
8-ply glued, moulded, natural varnished beechwood  
**High chair with wooden backrest and seat**

- Wooden XL backrest and XL seat
- Armrests with wooden surfaces -010 CH\*
- Step-up rail -04\*
- Height adjustment with safety gas spring (600–840mm)
- Polished diecast aluminium five-star base with glides

## WERKSITZ WORK CHAIRS MADE OF WOOD



**WS 1020 XL**  
8-ply glued, moulded, natural varnished beechwood  
**with XL wooden backrest and seat**

- Wooden XL backrest and XL seat
- Height adjustment with safety gas spring (440–620mm)
- Polished diecast aluminium five-star base with load-dependent braking castors
- Chrome-plated column cover\*



**WS 1010**  
8-ply glued, moulded, natural varnished beechwood  
**with wooden backrest and seat**

- Wooden backrest and seat
- Height adjustment with safety gas spring (420–600mm)
- Polished diecast aluminium five-star base with glides

Find an overview of the materials and colours we use on page 81.

Find an overview of the materials and colours we use on page 81.

**i** Acc. to **DIN 68 877**, a chair that can be adjusted to a height of **more than 650 mm** must be equipped with a **step-up rail**.

\* Accessories (see pages 78-81)

## WERKSITZ WORK CHAIRS CUSTOMISED ERGONOMICS

### Overhead work chairs – the best solution for ergonomic work

- They offer the ideal solution for fatigue-free overhead work.
- The height-adjustable headrest relieves neck muscles.
- It is also easy to install an XL backrest.
- Work is safer thanks to the parking brake.
- 5-notch tilt adjustment helps this chair adapt perfectly both to human physiology and the job at hand.
- You can install customised accessories such as armrests, armrest covers, storage boxes and tool holders any time.

We are happy to offer you an individual consultation and design a customised work chair for you.

- Break/folding seat**
- With folding mechanism
  - Soft PUR integral foam
  - Optionally available in wood, fabric or synthetic leather



” We are happy to help you find a solution to meet your needs!



**WS 1281 XL**  
Overhead work chair

- Lowered frame, galvanised or black powder-coated available
- With storage boxes, dimension according to customer requirements\*
- With headrest\*



**WS 1281 PLUS SH**  
Overhead work chair

- Raised, galvanised frame (black powder-coated also available)
- With storage boxes on request; custom dimensions on request\*
- Gas spring for synchronised tilt (seat and backrest)
- Headrest\*
- Parking brake\*

\* Accessories (see pages 78-81)

## WERKSITZ WORK CHAIRS INDIVIDUAL ERGONOMICS



**WS 1281 PLUS**  
Overhead work chair

- Seat tilt, continuously by gas spring
- Also available with headrest\*



**WS 1280 - 078H**  
Overhead work chair

- Lowered frame, galvanised or black powder-coated available
- With headrest\*



**WS 1220 E XL**  
Swivel chair with castors

- Soft PUR integral foam backrest and seat
- Height adjustment with safety gas spring
- Polished diecast aluminium five-star base
- With storage boxes and case\*
- With headrest\*



**WS 1382 KL**  
Overhead work chair

- Lowered frame, galvanised or black powder-coated available
- With storage area, galvanised, dimension according to customer requirements\*
- With headrest\*



## WERKSITZ WORK STOOLS FOR INDUSTRY AND WORKSHOPS



WS 4225

Also available in  
SOFT PUR  
integral foam



Find an overview of the  
materials and colours we use  
on page 81.



### WS 3610 PU

black (RAL 9005)

#### Assembly stool

- Assembly stool with harness
- Weighs just 5 kg
- Height adjustment with safety gas spring (380–470mm)
- Black plastic disc base
- Stool seat Ø 360 mm

### WS 4022

black (RAL 9005)

#### Low swivel stool

- Soft PUR integral foam seat
- Height adjustment with safety gas spring (380–470mm)
- Base: metal box surrounding the entire frame for storing tools or similar items, fitted with finely grooved mat

### WS 3520 KL RL Wave (V)

black (217x293)/fire red (207x1173)

#### Saddle stool

- Synthetic leather
- Height adjustment with safety gas spring (490–640mm)
- Chrome-plated column cover\*
- Polished diecast aluminium five-star base with load-dependent braking castors

### WS 3120

Wood, white 29-ply glued wooden seat

#### Stool with backrest bar

- Stool seat Ø 350 mm
- Chrome-plated backrest bar
- Varnished or stained in different colours on request
- Chrome-plated column cover
- Height adjustment with safety gas spring (490–680mm)
- Polished diecast aluminium five-star base with load-dependent braking castors

### WS 3010

Wood 8-ply glued wooden seat with clear varnish

#### Stool with wooden seat

- Stool seat Ø 350 mm
- Varnished or stained in different colours on request
- Height adjustment with safety gas spring (420–610mm)
- Polished diecast aluminium five-star base with glides

### WS 3020 PU Classic

black (RAL 9005)

#### Stool with Soft PUR integral foam

- Soft PUR integral foam seat
- Stool seat Ø 360 mm
- Available in all PUR colours\*
- Height adjustment with safety gas spring (450–640mm)
- Polished diecast aluminium five-star base with load-dependent braking castors



FOR EVERY AREA OF USE  
THE PERFECT WORK CHAIR  
FROM WERKSITZ

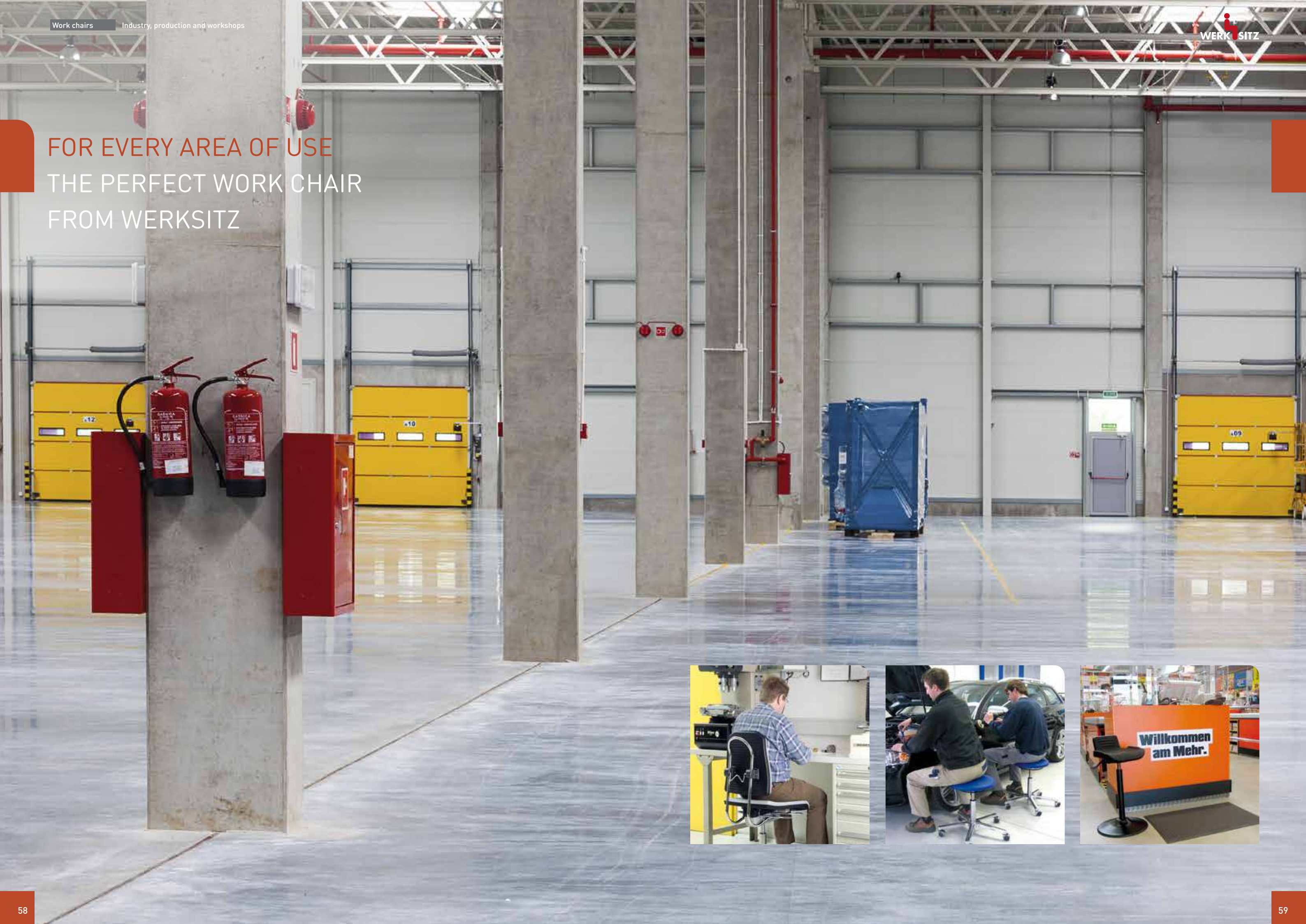



## WORK CHAIRS FOR ESD AREAS

Electrically conductive swivel chairs for protection against electrostatic discharge in accordance with the EN 61340-5-1 standard (conductivity  $10^4$ - $10^6$  ohm).



**WS 8220 ESD WERKSTAR – work chair**  
black (RAL 9005)

- With adjustable backrest contact pressure
- Soft PUR integral foam backrest
- Soft PUR integral foam seat with sliding range: 60 mm (in 10 mm increments)
- Height adjustment range (485 to 635 mm)
- Multifunctional lever for easy adjustment
- Electrically conductive for protection against electrostatic discharge



” Our assemblies are expensive and highly sensitive. We rely on electrically conductive chairs from WERKSITZ to protect our components against any possible electrostatic interferences.

## WERKSITZ CLASSIC CONDUCTIVE SWIVEL CHAIRS

The **WERKSITZ KLIMASTAR** work chair is also available in a conductive version.

WERKSITZ QUALITY-CHECK

10-YEAR WARRANTY



Also available in fabric designs.



**WS 9211.20 ESD**  
black (RAL 9005)

- Soft PUR integral foam backrest and seat
- Chrome-plated armrest -011 CH.90 with soft PUR integral foam covers\*
- Step-up rail\*
- Height adjustment with safety gas spring (610-850mm)
- Polished diecast aluminium five-star base with conductive sit-stop dual castors



**WS 1620 XL KL ERGO ESD**  
black (no. 217x293 ESD)

- Backrest and seat made from synthetic leather with conductive design
- Chrome-plated column cover\*
- Height adjustment with safety gas spring (460-640mm)
- Polished diecast aluminium five-star base with conductive castors



**WS 1220 E XL ESD**  
black (RAL 9005)

- Soft PUR integral foam backrest and seat
- Chrome-plated column cover\*
- Height adjustment with safety gas spring (460-640mm)
- Polished diecast aluminium five-star base with conductive castors

Find an overview of the materials and colours we use on page 81.

\* Accessories [see pages 19-20 and 78-81]

ⓘ Acc. to **DIN 68 877**, a chair that can be adjusted to a height of more than 650 mm must be equipped with a **step-up rail**.

# WORK CHAIRS FOR LABORATORIES AND CLEAN ROOMS

Select materials for ultimate functionality and hygiene.



Also available in an ESD model as an electrically conductive swivel chair for protection against electrostatic discharge in accordance with the EN 61340-5-1 standard.



**WS 9220 "Doctor's Chair"**  
light grey (RAL 7035)

- Soft PUR integral foam backrest and seat
- Chrome-plated cover tube
- Height adjustment with safety gas spring (450-620 mm)
- With armrest for taking blood -012 B
- Polished diecast aluminium five-star base
- With load-dependent braking
- Seat and backrest shell colour: light grey\*

WERKSITZ work chairs meet our high standards for cleanliness and hygiene in every way. We remain satisfied with our decision to purchase WERKSITZ work chairs to this day.

WERKSITZ QUALITY-CHECK	
10-YEAR WARRANTY	✓
	✓

## WERKSITZ CLASSIC – GMP LAB CHAIRS

### CLASSIC synthetic leather swivel chair

WERKSITZ synthetic leather is DIN 53160 certified to be:

- Disinfectant resistant
- Blood resistant
- Urine resistant
- Saliva resistant
- Sweat resistant



Find an overview of our imitation leather colours on page 81.



**WS 1320 KL ERGO GMP**  
lab mint (no. 109x4015)

- Synthetic leather Ergo backrest and seat
- Chrome-plated column cover\*
- Height adjustment with safety gas spring (460-640mm)
- Polished diecast aluminium five-star base with load-dependent braking castors

### CLASSIC Soft PUR integral foam lab chair

Perfect cleaning:

- Closed GMB seat support cover made of plastic and chrome-plated, polished metal parts
- All materials are washable and disinfectant resistant
- Suitable for S-classified laboratories
- Safety gas spring protected by column cover



**WS 1211 E T XL GMP colour**  
light grey (RAL 7035)

- Soft PUR integral foam backrest and seat
- Chrome-plated column cover
- Step-up rail -04 GMP\*
- Height adjustment with safety gas spring (650-860mm)
- Chrome-plated disc base

\* Accessories (see pages 78-81)



## WERKSITZ CLASSIC – GMP LAB CHAIRS FOR GMP AREAS

CLASSIC Soft PUR integral foam lab chair

CLASSIC Soft PUR integral foam lab chair

**Made especially for GMP areas:**

- Closed seat support cover made of plastic and chrome-plated, polished metal parts
- All materials are washable and disinfectant resistant
- Suitable for S-classified laboratories
- Safety gas spring protected by column cover



**WS 1210 E GMP XL T colour**  
light grey (RAL 7035)

- Soft PUR integral foam XL backrest and seat
- Chrome-plated column cover
- Height adjustment with safety gas spring (460–610mm)
- Chrome-plated disc base

**WS 1210 E GMP**  
black (RAL 9005)

- Soft PUR integral foam backrest and seat
- Chrome-plated column cover
- Height adjustment with safety gas spring (440–590mm)
- Polished diecast aluminium five-star base with glides

## WERKSITZ CLASSIC – GMP LAB CHAIRS FOR GMP AREAS

CLASSIC Soft PUR integral foam lab chair

CLASSIC Soft PUR integral foam lab high chair

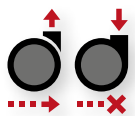

**WS 1220 E GMP XL**  
black (RAL 9005)

- Soft PUR integral foam backrest and seat
- Chrome-plated column cover
- Height adjustment with safety gas spring (460–610mm)
- Polished diecast aluminium five-star base with load-dependent braking castors

**WS 1211.20 E GMP colour**  
light grey (RAL 7035)

- Soft PUR integral foam backrest and seat
- Chrome-plated column cover
- Step-up rail -04 GMP\*
- Height adjustment with safety gas spring (690–900mm)
- Polished diecast aluminium five-star base with sit-stop castors

\* Acc. to **DIN 68 877**, a chair that can be adjusted to a height of **more than 650 mm** must be equipped with a **step-up rail**.

## WERKSITZ KLIMASTAR LAB CHAIRS



**WS 8220** light grey (RAL 9035)  
**Werkstar with soft PUR  
integral foam cushion**

- With adjustable backrest contact pressure
- Soft PUR integral foam backrest, (W top/bottom x H: 210/440 x 500 mm) backrest tilt: 0° to -20° (in 5° increments)
- Soft PUR integral foam seat with sliding seat mechanism, (W x D: 465 x 460 mm) seat tilt: 0° to +5° (in 2.5° increments) sliding range: 60 mm (in 10 mm increments)
- Height adjustment range: 485 to 635 mm
- Multifunctional lever for easy adjustment
- Polished five-star base (Ø 690 mm), with dual castors (Ø 65 mm)
- Chrome-plated cover tube\*



**WS 9211** ultramarine blue (RAL 5002)  
**KLIMASTAR Soft PUR integral foam  
high chair**

- Soft PUR integral foam backrest and seat
- Armrests -010 CH.90\* with Soft PUR integral foam covers
- Chrome-plated column cover\*
- Step-up rail -04.90\*
- Height adjustment with safety gas spring (610–850mm)
- Polished diecast aluminium five-star base with glides

## WERKSITZ LABOR CLEAN ROOM CHAIRS



### Clean room chair

#### Sturdy and hygienic:

- Certified for class-5 clean rooms according to the DIN EN ISO 14644-1 standard
- WERKSITZ synthetic leather is urine, blood and sweat resistant in accordance with the DIN 53160 standard

### Clean room high chair

#### Perfect cleaning:

- All materials are washable and disinfectant resistant

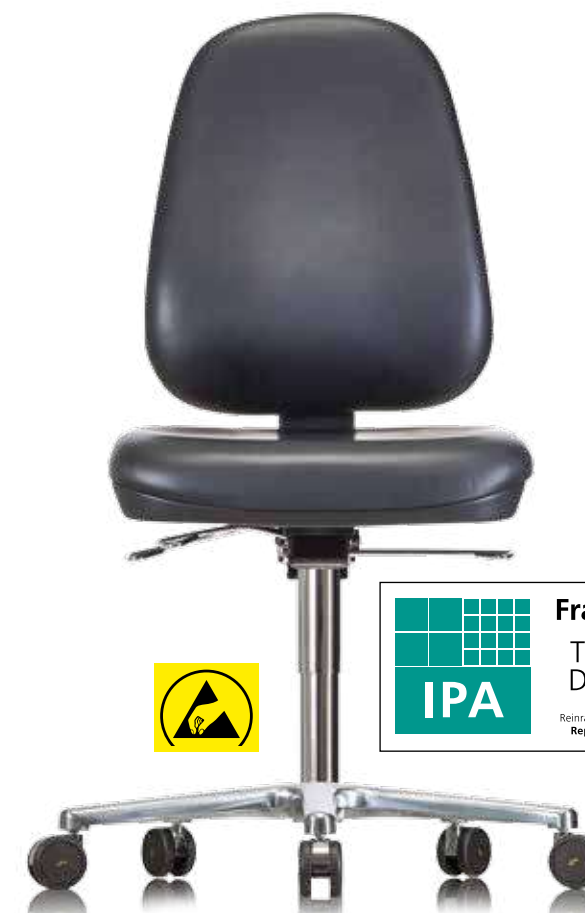

**WS 1720 RR ESD**

Black synthetic leather (no. 217x293 ESD)

- Synthetic leather backrest and seat
- Chrome-plated column cover
- Height adjustment with safety gas spring (510–630mm)
- Polished diecast aluminium five-star base with conductive castors



**WS 1711 T RR ESD**

Black synthetic leather (no. 217x293 ESD)

- Synthetic leather backrest and seat
- Chrome-plated column cover
- Height adjustment with safety gas spring (670–880mm)
- Foot ring -05 ESD\*
- Chrome-plated disc base



Also available with armrests\* (-011 CH.17).

\* Accessories (see pages 19-20 and 78-81)

1 Acc. to DIN 68 877, a chair that can be adjusted to a height of more than 650 mm must be equipped with a **step-up rail**.



# WERKSITZ CLASSIC – GMP

## STANDING SUPPORTS AND STOOLS

Find an overview of the materials and colours we use on page 81.

### Standing support

#### Ergonomics

- Tilt adjustment between +2° and +28°
- Seat height adjustment using a safety gas spring
- Swivel stool for relaxed posture while seated and optimum freedom of movement at any height



**WS 4211 T GMP colour**  
light grey (RAL 7035)

- Soft PUR integral foam seat
- Chrome-plated column cover
- Height adjustment with safety gas spring (630–840mm)
- Chrome-plated disc base

### Stool

**WS 3020 PU Classic GMP**  
light grey (RAL 7035)

- Soft PUR integral foam seat
- Chrome-plated column cover
- Height adjustment with safety gas spring (450–640mm)
- Polished diecast aluminium five-star base with foot release\* and load-dependent braking castors
- Foot release -079\*



### Saddle stool with backrest

#### Perfect cleaning:

- All materials are washable and disinfectant resistant
- Suitable for S-classified laboratories



**WS 3520 KL GMP RL (V)**  
light grey (no. 207x2396)

- Synthetic leather seat and backrest
- Chrome-plated column cover
- Height adjustment with safety gas spring (510–660mm)
- Polished diecast aluminium five-star base with load-dependent braking castors



WERKSITZ  
QUALITY-CHECK

10-YEAR WARRANTY

\* Accessories (see pages 78-81)

# STAINLESS STEEL WORK CHAIRS

For special cleanliness and hygiene requirements



Even our work chairs shine every day. Cleanliness is extremely important, especially in our work. After all, we want our excellent performance to shine.



**WS 1411**  
light grey (RAL 7035)\*

- with step-up rail -14/08\*
- with key groove mechanism
- Stainless steel five-star base with glides

WERKSITZ QUALITY-CHECK	
5-YEAR WARRANTY	

\* Acc. to DIN 68 877, a chair that can be adjusted to a height of more than 650 mm must be equipped with a step-up rail.

# WERKSITZ WORK CHAIRS MADE OF STAINLESS STEEL (V2A) FOR WET ROOMS

## Glide chair for wet rooms

## Chair with castors for wet rooms

Also available with HPU coating for special hygiene requirements:

- Water repellent (based on sealed surface)
- Acid and solvent resistant
- Free of solvents, plasticisers and AZO dyes
- Heat resistant up to 100°C for short periods



**WS 1410 GF**  
black (RAL 9005)

- Soft PUR integral foam backrest and seat
- Height adjustment with safety gas spring (480–640mm). Limited warranty for wet rooms. Gas spring should be replaced every two years.
- Stainless steel five-star base with glides

\* Available for an additional charge



**WS 1420 GF**  
light grey (RAL 7035)\*

- Soft PUR integral foam backrest and seat
- Height adjustment with safety gas spring (535–695mm). Limited warranty for wet rooms. Gas spring should be replaced every two years.
- Stainless steel five-star base with load-dependent braking castors



# WERKSITZ STANDING SUPPORTS MADE OF STAINLESS STEEL (V2A) FOR WET ROOMS



## Wet room standing supports

### For special hygiene requirements:

- Good water resistance
- Heat resistant up to 100 °C for short periods



### WS 145050 Wet room footrest

- Sturdy tube construction
- 500 x 300 mm (W x D)
- Anti-slip footrest tilt adjustment from 0° to 20°, mounted on pendulum bearings



### WS 144211 black (RAL 9005)

- Soft PUR integral foam seat (free of solvents, plasticisers and azo dyes)
- Seat (W x D) 390 x 350 mm
- Height adjustment range: 540–780 mm (with key groove mechanism)
- Stainless steel construction (acid and solvent resistant)

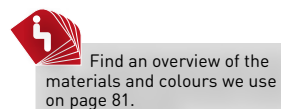

Find an overview of the materials and colours we use on page 81.



### WS 144211 U tele grey (RAL 7045)\*

- Soft PUR integral foam seat
- Seat (W x D) 390 x 350 mm
- Height adjustment range: 700–840 mm (with key groove mechanism)





# WORK CHAIRS FOR PEOPLE WITH DISABILITIES

WERKSITZ offers sophisticated ergonomic workplace design solutions for people with disabilities. Workshops for people with disabilities manufacture WERKSITZ chair components that meet the highest standards.



## WS 1388.10 XL KL ERGO chair for epileptics

Synthetic leather backrest and headrest two-colour design\* dark grey (no. 207x3120) / turquoise (no. 208x797)

- Two-colour design\*
- Synthetic leather XL backrest with extended bracket
- Large seat
- With headrest
- Safety harness
- Safety armrests
- Safety gas spring for height adjustment (435–615 mm)
- Asymmetrical five-star base with foot ring -051 and anti-slip footrest, extended\*, infinitely variable adjustment at the column
- Five-star base with glides

# THE RIGHT CHAIR FOR EVERYONE

## WS 1387.20, two-colour, designed especially for people of small stature

Black synthetic leather (no. 217x293) / fabric, denim blue (no. 12267)

- Two-colour design\*
- Shorter backrest 410 x 250 mm (W x D)
- Shorter seat 430 x 320 mm (W x D)
- Height adjustment with safety gas spring (350–470mm)
- Armrests available on request
- Polished diecast aluminium five-star base with load-dependent braking castors

## WS 1389.20 KL, two-colour, designed especially for heavy persons up to 175 kg

Black synthetic leather (no. 217x293) / dark grey (no. 207x3120)

- Two-colour design\*
- Extra large seat 540 x 470 mm (W x D)
- Extended bracket
- Height adjustment with safety gas spring (550–660mm)
- Chrome-plated column cover
- Depth spring action
- Reinforced seat support plate
- Polished diecast aluminium five-star base with load-dependent braking castors
- Chair: 5-year warranty, castors: 2-year warranty



## WS 1389 KL, two-colour, designed especially for heavy persons up to 250 kg

Black synthetic leather (no. 217x293) / fire red (no. 207x1173)

- Two-colour design\*
- Extra large seat 610 x 540 mm (W x D)
- Armrests\*
- Extended bracket
- Height adjustment with safety gas spring (510–660mm)
- Chrome-plated column cover
- Depth spring action
- Reinforced seat support plate
- Polished diecast aluminium five-star base with glides



Find an overview of the materials and colours we use on page 81.

\* Acc. to DIN 68 877, a chair that can be adjusted to a height of more than 650 mm must be equipped with a step-up rail.



## THE RIGHT CHAIR FOR EVERYONE

### WS 1228 E XL

Soft PUR integral foam  
Backrest signal red (RAL 3001)\*  
Seat black (RAL 9005)

- Soft PUR integral foam backrest and seat
- Armrests height and width adjustable
- Side upper body support
- Foot ring 051
- Therapy chair frame 660 x 720 mm, with sliding bar and double apparatus castors Ø 75 mm
- Foot brake
- Mount for walking aid (without walking aid)



### WS 1399.20 KL ERGO arthrodesis chair

Saphire blue synthetic leather (no. 207x729)

- Seat 490 x 430 mm (W x D)
- With safety armrests\*
- With lap belt\*
- Specially designed for people with leg amputations or legs with different lengths
- Retractable seat front parts, upholstered as standard
- Height adjustment with safety gas spring (450–630mm)
- Polished diecast aluminium five-star base with load-dependent braking castors



 Find an overview of the materials and colours we use on page 81.



\* Accessories (see pages 78-81)



# OVERVIEW OF ACCESSORIES



## Headrests

 Order no.: -102 549 ■ with 3D honeycomb fabric	 Order no.: -102 685 ■ with synthetic leather	 Order no.: -102 571 ■ with fabric	 Order no.: -101 697 ■ with 3D honeycomb fabric	 Order no.: -100 824 ■ with synthetic leather	 Order no.: -100 849 ■ with fabric
---	---	--	---	---	--

## Armrests (in pairs)

 Order no.: -010 ■ With Soft PUR integral foam covers ■ Black powder-coated column	 Order no.: -010CH* ■ With Soft PUR integral foam covers ■ Chrome-plated column	 Order no.: -010 ■ With wooden surfaces ■ Black powder-coated column	 Order no.: -010CH* ■ With wooden surfaces ■ Chrome-plated column	 Order no.: -010H* ■ Hard plastic multifunctional armrests height-adjustable
 Order no.: -011 ■ Hard plastic safety ring armrests	 Order no.: -011D ■ Hard plastic safety ring armrests with a modern design	 Order no.: -011H ■ Hard plastic, height-adjustable safety armrests	 Order no.: -012 ■ Safety armrests with wooden surfaces (also available with Soft PUR integral foam covers) ■ Chrome-plated or black powder-coated tubing ■ Height and width adjustable	 Order no.: -012CH*
 Order no.: -011CH ■ With Soft PUR integral foam covers ■ Chrome-plated column	 Order no.: -010H ALU ■ Hard plastic multifunctional height-adjustable armrests with polished aluminium supports	 Order no.: -012B* ■ Armrests for taking blood, height-adjustable	<b>WERKSTAR multifunctional armrests, all height adjustable by 100 mm</b> <ul style="list-style-type: none"> <li>Order no. 1D 8xx</li> <li>Order no. 2D 8xx, additionally width adjustable by 2x38 mm</li> <li>Order no. 3D 8xx, armrests additionally with 30° swivel action</li> <li>Order no. 4D 8xx, armrests additionally with 30° swivel action, width adjustable by 2x38mm</li> </ul>	

\* also available in an ESD model



## Belts

 Order no.: -072.1 ■ Only in combination with -010, -011 or -012 armrests	 Order no.: -072.2 ■ Only in combination with -011 armrests
---	---

## Chair columns with gas springs

	Dimensions for PUR cover	Dimensions for fabric cover	Dimensions for wooden cover
■ For chairs with glides			
Order no.: -074.10	540-780 mm	540-780 mm	520-760 mm
Order no.: -073.10	360-480 mm	360-480 mm	340-460 mm
Order no.: -077.10	310-380 mm	310-380 mm	290-360 mm
■ For chairs with castors			
Order no.: -074.20	570-830 mm	570-830 mm	560-820 mm
Order no.: -073.20	370-490 mm	370-490 mm	350-470 mm
Order no.: -077.20	330-400 mm	330-400 mm	310-380 mm

## Step-up rails for high chairs

 Order no.: -04 ■ Height adjustment range: 60 mm ■ Follows the rotation of the chair. ■ Also available in ESD and GMP <sup>1</sup> designs	 Order no.: -04.80 Order no.: -04.90	 Order no.: -06 ■ Height adjustment range: 60 mm ■ Tilt-adjustable by 23° ■ With anti-slip footrest ■ Follows the rotation of the chair. ■ Also available in ESD and GMP <sup>1</sup> designs	 Order no.: -06.80 Order no.: -06.90	 Order no.: -08 ■ With anti-slip design ■ Follows the rotation of the chair
--	--	---	--	--

<sup>1</sup> WERKSTAR excluded

## Foot rings

 Order no.: -05 Ø 540 mm Order no.: -05K Ø 440 mm ■ Chrome-plated with separate clamp and plastic bushing ■ Also available in ESD and GMP designs	 Order no.: -05K Ergo Ø 440 mm ■ Chrome-plated with separate clamp
---	---

## Swivel locks

Just a few examples:  Order no.: -07 -07.90  Order no.: -0711  Order no.: -0711.80  Order no.: -0711.90	Swivel locks are available in a number of different designs for all KLIMASTAR and CLASSIC chairs.
--	---

## Column cover



## Five-star bases

WERKSTAR polished diecast aluminium five-star base with glides (xx10) 	Polished diecast aluminium five-star base with castors or glides 	Polished diecast aluminium five-star base for high chairs with glides (-076) 
WERKSTAR polished diecast aluminium five-star base with castors (xx20) 	Plastic five-star base with castors (also for high chairs) or glides 	Polished diecast aluminium five-star base for high chairs, with sit-stop dual castors 

## Disc bases

Available in 2 different sizes (Ø 420 and Ø 550 mm), 3 different colours, optionally with PUR moulded edge

Order no.: T420 or TPU430  
 Order no.: T550 or TPU560

Only size Ø 550 mm, without PUR edge, Order no. T550



# OVERVIEW OF ACCESSORIES



## Parking brakes

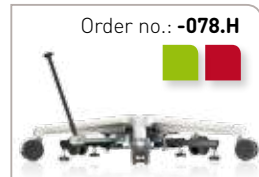

- Black powder-coated
- With hand release lever (250 mm long)
- Only in combination with xx20 diecast aluminium five-star bases

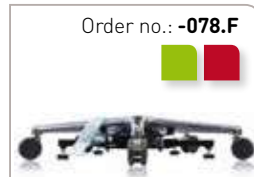

- Black powder-coated
- With chrome-plated foot pedal
- Only in combination with xx20 diecast aluminium five-star bases

## Foot release



- Effortless height adjustment and contamination-free work while comfortably seated

## Castors



- All WERKSITZ dual castors feature load-dependent braking. We offer a selection of different load-dependent braking castor models for hard, soft and ESD surfaces.

## Separate footrests



- Sturdy, black powder-coated round tube construction
- Anti-slip wooden footplate
- Width 350 mm, depth 300 mm
- Tilt adjustment from 0° to 20°, mounted on pendulum bearings
- Height adjustment range from 120 to 250 mm



- Sturdy, black powder-coated round tube construction
- Anti-slip wooden footplate
- Width 500 mm, depth 300 mm
- Tilt adjustment from 0° to 20°, mounted on pendulum bearings
- Height adjustment range from 120 to 410 mm



- Sturdy, black powder-coated round tube construction
- Height adjustable by foot release
- Anti-slip wooden footplate
- Width 500 mm, depth 300 mm
- With height adjustment using a safety gas spring
- Tilt adjustment from 0° to 20°, mounted on pendulum bearings
- Height adjustment range from 170 to 310 mm



- Sturdy round tube construction
- Anti-slip metal footplate
- Width 500 mm, depth 300 mm
- Tilt adjustment from 0° to 20°, mounted on pendulum bearings
- Suitable for foot switch
- Height adjustment range from 120 to 410 mm
- Also available in an ESD model (WS 5050 ESD)**



- Wet room footrest
- Sturdy tube construction
- Anti-slip footrest
- Width 500 mm, depth 300 mm
- Tilt adjustment from 0° to 20°, mounted on pendulum bearings
- Height adjustment range from 120 to 410 mm



- Foot release with built-in button



- Chrome-plated

# THE CHOICE IS YOURS - OUR COLLECTION OF COLOURS

Printed colours may differ slightly from the actual colours.

## Soft PUR integral foam



Black is the standard colour used; all other colours available for an additional charge (except WERKSTAR and KLIMASTAR model).

## Synthetic leather<sup>2)</sup> (flame retardant - except for lab mint colour)

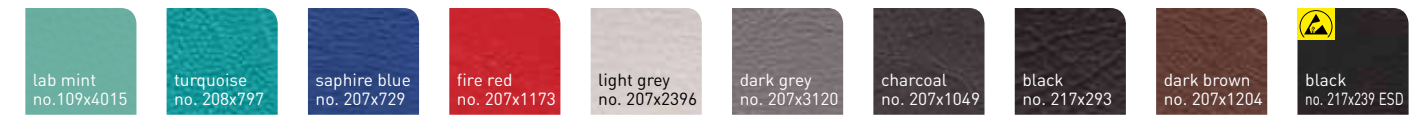

- 3) Wave-design available on request
- perforated
- Comfortable seating, air permeable, durable, dirt-repellent, cold/heat resistant, blood/urine resistant, disinfectant resistant. All colours available without extra charge.

Also available in genuine leather on request.  
Alcantara leather with custom embroidery available on request.

## Tiffany (only available for Werkstar)

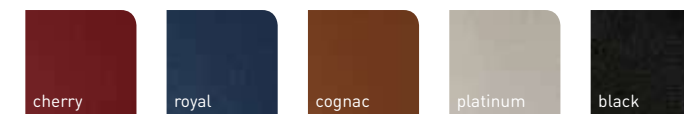

## Black Amazona

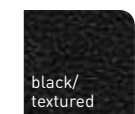

## Fabric<sup>2)</sup>

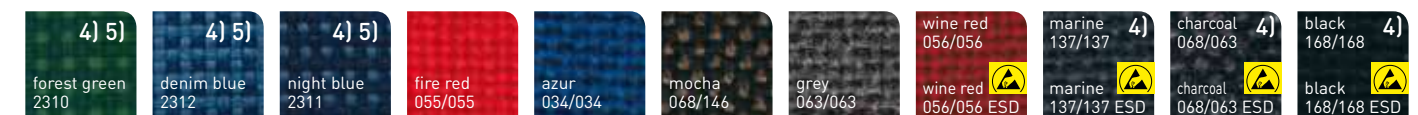

100% acrylic or 95% acrylic + 5% polyester on ESD models or 100% Trevira CS on flame-retardant designs.

Also available with a conductive design

Free of AZO dyes, 100% CFC-free manufacturing, conforms to all European environmental directives.

## NEW NANOTEX fabric - dirt-repellent and flame retardant B1



## 3D honeycomb fabric<sup>2)</sup>



Other colours available on request. Honeycomb thickness 2 mm

## Two-colour (only available for Werkstar)



## Wood

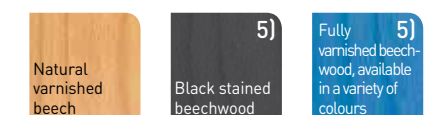

100% Polyester. Highly breathable, excellent air circulation, highly elastic, very good shape recovery, antiallergenic and poses no health risks. Helps protect against mould and mites.

- 1) Also available on request.
- 2) Does not apply to the WERKSTAR series
- 3) A range of colours available on request / for an additional charge
- 4) Also available in flame-retardant versions in accordance with the DIN 4102 B1 standard (not ESD)
- 5) Available with extra charge



## TRADITION AND THE ENVIRONMENT

Committed to our Franconian family tradition. An intact environment is the basis for lasting value and sustainable progress. At WERKSITZ we develop ergonomic workplaces for people and feel especially responsible for protecting the environment. We are committed to this responsibility, we protect our important ecological resources and we produce the majority of our components in Germany.

Here at WERKSITZ we may be known as the “specialists for workplace ergonomics”, but our environment and a healthy climate play just as important a role in everything we do.

- We are members of and participants in the Bavarian Environmental Pact – and we comply with all European environmental directives.
- We never use AZO dyes or chlorofluorocarbons (CFC), we work exclusively with silicone-free materials and we always adhere to PAH guidelines and REACH regulations.



**Health and  
our environment –  
we are committed  
to both!**





# WERKSTEP WORKPLACE MATS

Promotes health and prevents injury thanks to safe, healthy standing.

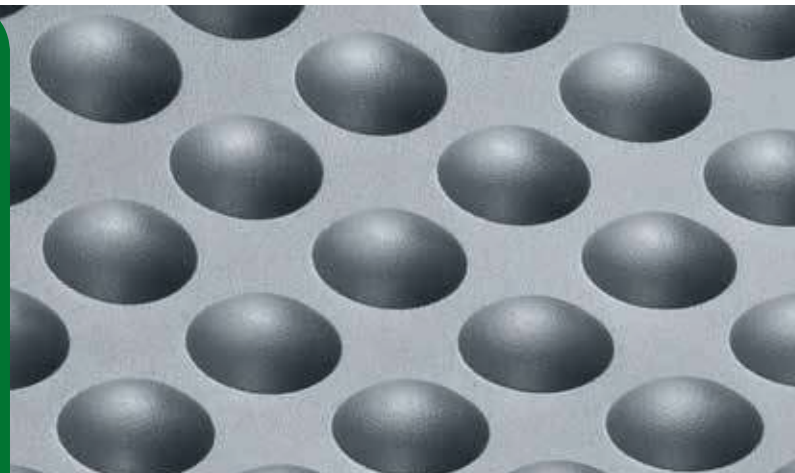

” This investment really paid off for us! Our employees benefit from an ergonomic workplace that puts health and safety first. This makes everyone more motivated and productive.

## WERKSTEP workplace mats – the right choice for standing workstations

Our bodies are not made for walking or standing on hard floors. Constant standing puts pressure on our back, placing a heavy load on our musculoskeletal system. The non-physiological curvature of the spine places stress on the intervertebral discs.

Physical activity inhibits the necessary metabolism between the intervertebral discs and the vertebral bodies. Constant standing also causes the muscles to work statically, which in turn impairs blood circulation in the muscles.

### Making healthy standing easy!

The elastic texture and knobby surface of WERKSTEP work mats reduce the stress placed on bones, joints and muscles. Pressure on the sensitive toe and ball sections of the foot is reduced considerably as the mats cushion the weight of the body. This helps keep the feet in motion, imperceptibly stimulating circulation. The WERKSTEP workplace mat promotes blood circulation in the legs.

WERKSTEP workplace mats promote health and prevent injury, helping employees stand continuously without placing undue stress on their bodies.

### The WERKSTEP range of products

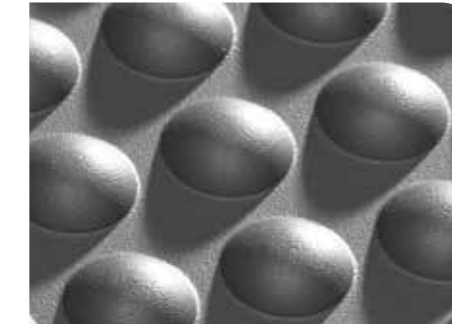

**WERKSTEP Comfort mat:** The universal, extremely rugged mat for wet and dry areas.



**WERKSTEP Drehfit Comfort mat:** The mat for workplaces that require frequent rotating.

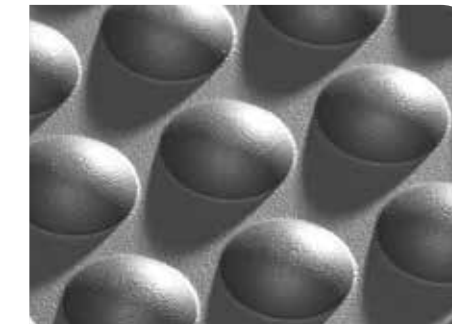

**WERKSTEP Classic mat:** The rugged, economical mat for all dry areas.



**WERKSTEP Hydrofit mat:** The mat for workplaces exposed to water, oil or chips and shavings.

### So many great reasons

The WERKSTEP workplace mat is an ergonomic floor covering that has been researched and tested to respond to the permanent stress of standing workstations.

The basic material is made of polyurethane, a closed cell structure with a durable surface featuring a silky matte finish and visually appealing outer skin. WERKSTEP workplace mats are made using an especially dense basic material that provides a stronger return force for superb durability.

#### WERKSTEP workplace mats feature:

- High wear resistance
- Good behaviour characteristics even at extremely low temperatures
- Extraordinary ageing resistance
- Long life
- Extreme dimensional stability
- Durability
- Environmental compatibility (free of silicone, CFC, HCFC, PVC, propellant gas and solvents)

#### Protecting, insulating and easy to care for

WERKSTEP workplace mats protect and insulate floor coverings and ground surfaces. Their attractive design creates a clean, friendly workplace atmosphere. They are easy to handle and clean.

#### Flexible and individual

The standard dimensions of 60 x 90 cm can be adapted to create custom-tailored solutions for workstations of any size or shape. Our variety of styles leaves nothing to be desired.

#### Select from:

- A variety of materials
- A range of colours
- Anti-static design
- Anti-slip
- Flame retardant
- Water repellent

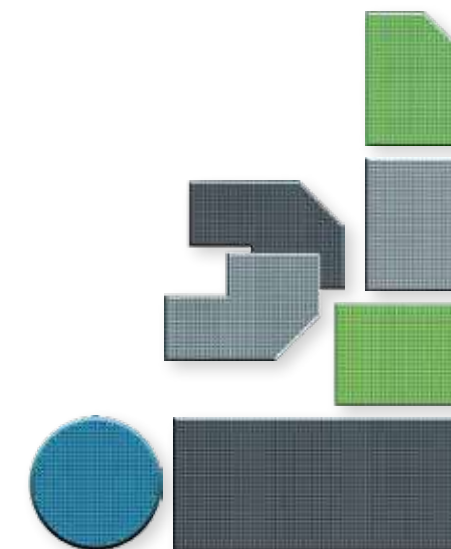



5-YEAR WARRANTY ✓

3-YEAR WARRANTY ✓

# WERKSTEP WORKPLACE MATS

## SUITABLE FOR ALL TYPES OF APPLICATIONS

### WERKSTEP Comfort



**Use:**

- In wet and dry areas

**Material:** Polyurethane on polyether basis

**Properties:**

- Colour: charcoal
- Weight: 3 kg, thickness: 14 mm
- Temperature resistance: -35 °C to +95 °C
- Electrical resistance: 10<sup>6</sup> Ω (on ESD model)
- Flame retardant (fire class: B1 according to DIN 4102/FMVSS 301)

**Optional design:**

- Anti-static
- Anti-slip
- Colour
- ESD model 

**Surface:** knobbly  
**Underside:** smooth

### WERKSTEP Drehfit Comfort



**Use:**

- In wet and dry areas
- For workplaces that require frequent rotating

**Material:** Polyurethane on polyether basis

**Properties:**

- Colour: charcoal
- Weight: 3 kg, thickness: 12 mm
- Temperature resistance: -35 °C to +85 °C
- Electrical resistance: 10<sup>6</sup> Ω (on ESD model)
- Flame retardant (fire class: B1 according to DIN 4102/FMVSS 301)

**Optional design:**

- Anti-static
- Anti-slip
- Colour
- ESD model 

**Surface:** flattened, knobbly surface  
**Underside:** smooth

### WERKSTEP Duofit Comfort



**Use:**

- In wet and dry areas

**Material:** Polyurethane on polyether basis

**Properties:**

- Colour: charcoal
- Weight: 3 kg, thickness: 14 mm
- Temperature resistance: -35 °C to +95 °C
- Electrical resistance: 10<sup>6</sup> Ω (on ESD model)
- Flame retardant (fire class: B1 according to DIN 4102/FMVSS 301)

**Optional design:**

- Anti-static
- Colour
- ESD model 

**Surface:** knobbly  
**Underside:** knobbly surface for maximum standing comfort and anti-slip protection

### WERKSTEP Classic



**Use:**

- Mainly in dry areas

**Material:** Polyurethane

**Properties:**

- Colour: charcoal
- Weight: 3 kg, thickness: 14 mm
- Temperature resistance: -40 °C to +80 °C
- Electrical resistance: 10<sup>6</sup> Ω (on ESD model)

**Optional design:**

- Anti-static
- Anti-slip
- Colour
- ESD model 

**Surface:** knobbly  
**Underside:** smooth

### WERKSTEP Drehfit Classic



**Use:**

- Mainly in dry areas
- For workplaces that require frequent rotating

**Material:** Polyurethane

**Properties:**

- Colour: charcoal
- Weight: 3 kg, thickness: 12 mm
- Temperature resistance: -40 °C to +80 °C
- Electrical resistance: 10<sup>6</sup> Ω (on ESD model)

**Optional design:**

- Anti-static
- Anti-slip
- Colour
- ESD model 

**Surface:** flattened, knobbly surface  
**Underside:** smooth

### WERKSTEP Duofit Classic



**Use:**

- Mainly in dry areas

**Material:** Polyurethane

**Properties:**

- Colour: charcoal
- Weight: 3 kg, thickness: 14 mm
- Temperature resistance: -40 °C to +80 °C
- Electrical resistance: 10<sup>6</sup> Ω (on ESD model)

**Optional design:**

- Anti-static
- Colour
- ESD model 

**Surface:** knobbly  
**Underside:** knobbly surface for maximum standing comfort and anti-slip protection



# WERKSTEP WORKPLACE MATS FOR WET ROOM AREAS

5 to 8-YEAR WARRANTY  
depending on model ✓

## WERKSTEP Hydrofit NBR

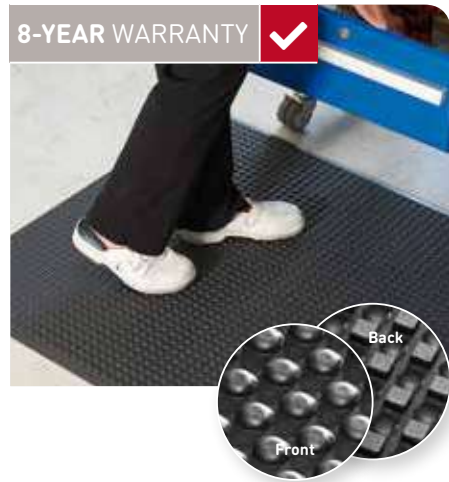

**Use:**  
■ For workplaces exposed to water, oil or chips and shavings

**Material:** Nitrile, NBR

- Properties:**
- Colour: black
  - Weight: 5.7 kg, thickness: 14.5 mm
  - Temperature resistance: up to +100°C for short periods
  - Electrical resistance: 10<sup>6</sup> Ω (on ESD model)
  - Resistant against common industrial acids, bases, oils, hydrolysis resistant
  - Suitable for welding stations

- Optional design:**
- Anti-static
  - Flame retardant (fire class: B1 according to DIN 4102/FMVSS 302) – 5-year warranty
  - Perforated design to drain off liquids
  - ESD model – 5-year warranty

**Surface:** knobbly  
**Underside:** Textured underside for better adhesion, water-repellent effect

## WERKSTEP Food-Grade Mat



**Use:**  
■ For dry and wet food preparation areas, OP, lab or hygiene areas

**Material:** Nitrile, NBR

- Properties:**
- Colour: black or tele grey
  - Weight: 6.7 kg (black), 5.8 kg (tele grey), thickness: 14.5 mm
  - Temperature resistance: +96°C for 8 hours

**Surface:** knobbly  
**Underside:** Textured underside for better adhesion, water-repellent effect

## WERKSTEP Food-Grade Mat



# PUBLISHER INFORMATION & IMAGE CREDITS

## WERKSITZ GmbH W.Milewski

Telefunkenstraße 9  
D-97475 Zeil am Main  
Phone +49 (0) 9524 8345-0

[info@werksitz.de](mailto:info@werksitz.de)  
[www.werksitz.de](http://www.werksitz.de)

Headquarters: Zeil am Main, Germany  
Managing Directors: Wolfgang & Genevieve Milewski  
Bamberg District Court Commercial Register  
Page HRB 579  
VAT ID no.: DE 811 2085 14  
Responsible Chamber of Commerce:  
IHK-Würzburg-Schweinfurt

© WERKSITZ GMBH, Zeil am Main

## IMAGES

Peter Weigelt Photography

Lightning in meadow ■ © GIS – Fotolia.com  
Marmo e Alpi Apuane ■ © gdfotostudiolab – Fotolia.com  
blood bank laboratory ■ © angellodeco – Fotolia.com  
Waldweg im Sommer ■ © Thomas Otto – Fotolia.com  
Close up of laboratory treatment ■ © Kesu – Fotolia.com  
Zwei Hände, die sich halten ■ © Nelos – Fotolia.com  
Modern Warehouse ■ © malajscy – Fotolia.com  
couple ■ © muro – Fotolia.com  
businnessman sitting on beach ■ © peshkova – Fotolia.com  
Regentropfen auf Autolack ■ © Konrad Fotodesign – Fotolia.com  
Workers In Warehouse Preparing Goods For Dispatch ■ © Monkey Business – Fotolia.com  
Orme sulla spiaggia ■ © Dario Airoldi – Fotolia.com  
Construction worker operating a machine ■ © ikonoklast\_hh – Fotolia.com  
Assemblage ■ © kalou1927 – Fotolia.com  
Zahntechnikerin im Labor ■ © Robert Kneschke – Fotolia.com  
Male And Female Scientists Using Microscopes In Laboratory ■ © Monkey Business – Fotolia.com  
Frau an Drehbank ■ © ehrenberg-bilder – Fotolia.com  
Female Chef In Restaurant Kitchen ■ © Tyler Olson – Fotolia.com  
Man sitting at desk in wheelchair ■ © auremar – Fotolia.com  
Kfz Mechanikerin in einer Autowerkstatt ■ © ikonoklast\_hh – Fotolia.com  
young smiling engineer taking notes at control room ■ © GVS – Fotolia.com  
red carpet, green abstract light background, laboratory woman ■ © shutterstock.com

## CONCEPTUAL DESIGN

ADALIS.de

# REFERENCES

## Some of our customers

ABB	EADS	Max Planck Institut	Tesa
AB Elektronik	Enercon	Melitta	Tchibo
Airbus	Ernstings Family	Michelin	Thyssen Krupp
Alaska Airlines	Finn Comfort	Miele	TRW
Aleo Solar	Ford	Mitsubishi	
AMC Deutschland	Frankfurt Airport	MTU	Unilever
apetito	Fraunhofer Institut		Universtät Bonn
Arbeiterwohlfahrt		Nato	
Audi	Gabor	Nestlé	Volkswagen AG
	Galeria Kaufhof	Nokia	
Bahlsen	Gerry Weber	NUR DIE	Werkstätten für behinderte Menschen
BASF	General Electric (GE)		Whirpool
Bayer AG	Gillette	Obi	
Berendsen	Goodyear Dunlop	Olympus	Yves Rocher
BMW	Griesson – de Beukelar		
Boeing USA		Peugeot	
Bonn University	Herend	Pluradent	Zwilling
Bosch Rexroth	Hermès Frankreich	Polarforschungsinstitut	
Bundespolizei	Hugo Boss	Postbank	
Bundeswehr	Hyundai	Post Con Deutschland	
		PSA PEUGEOT	
Caritas Werkstätten	Ideal Standard		
CeWe Color		Rewe	
Christian Dior	Jack Wolfskin	Robert Bosch	
Continental Automotive GmbH			
Coppenrath und Wiese	L'Oreal	Schaeffler	
	LEAR Automotive Electronics	Siemens VDO, Electrotechnics	
Daimler Chrysler	Leiden University	SFK Berlin	
DANONE		Spanish National Cancer Center	
DB Fernverkehr AG	Kaufhof	Star Engineers, India	
DB Schenker	Keetronics, India	Sto AG	
Dentallabore	Kraft		
Deutsche Bundesbank			
Disney Land Paris			
Dresden Airport			
Dr. Oetker			





**WERKSTEP  
WORKPLACE  
MATS**

Promotes health and  
prevents injury thanks  
to safe, healthy  
standing

pages  
84-89

**WERKSITZ GmbH W. Milewski**  
Telefunkenstr. 9 | D-97475 Zeil am Main  
Tel. +49 9524 8345-0 | Fax +49 9524 8345-19  
info@werksitz.de | www.werksitz.de