

Info: Silensor-sl, anti-snoring device

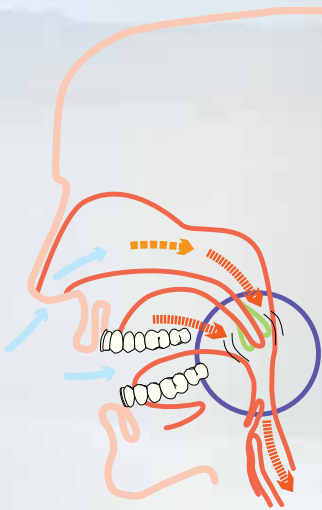

Snoring is generated in the area of the upper respiratory system. Caused by acceleration of the air flow when the respiratory tract is cramped (pharynx) parts of the soft tissue start to vibrate and cause the snoring noise.

The apnea is a total respiratory stop. The obstructive apnea is a mechanical relocation of the respiratory tract. In case of a central apnea the central respiratory reflex fails. The hypopnea is a reduction of the air flow of more than 50%.

The apnea / hypopnea index, AHI is the degree for the severity of the disease. An apnea / hypopnea lasts at least 10 sec.

To determine the index the number of apneas is divided by the hours of sleep. An index of 0 to 5 is normal, an index of 5 to 10 is a matter of a light, 10 to 20 of a median and more than 20 of a severe disease.

An obstructive apnea is characterized by an interruption of the very noisy rhonchopathy.

Snoring and the obstructive sleep apnea are a mechanical process that can be counteracted mechanically. Here the dental therapy comes into action.

Many studies have shown the effectiveness of mandibular advancement splints, including the very comfortable **Silensor-sl**. The expansion of the pharyngeal area reduces its tendency to collapse and the AHI by up to 50%. The also slowed down airflow reduces snoring by up to 80%.

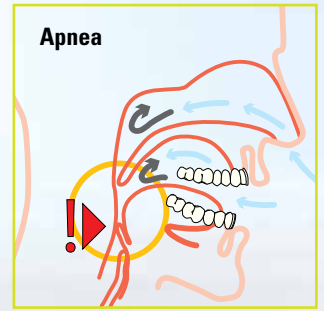

The Silensor-sl is a mandibular advancement splint (MAS):

- adjustable advancement
- highly comfortable
- effective improvement of the symptoms
- metal-free construction

5

5 further important features:

In the molar area of the lower the connector clicks into place weakly. In case of sudden propulsion movements during sleep the anchor can slide into the connector (fig.).

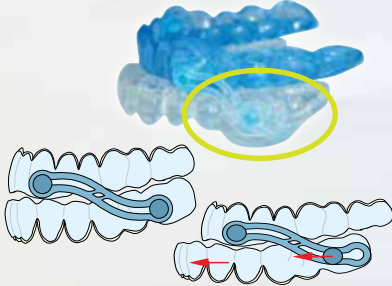

This avoids compressing and overloading the connectors.

A light flexing (fig.) of the S shaped connectors improves the wearing comfort and reduces load in the connecting area of all parts.

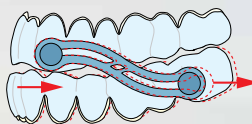

In case of a needed different position of the lower, the connectors can be changed very easily. 6 different sizes are provided (fig.).

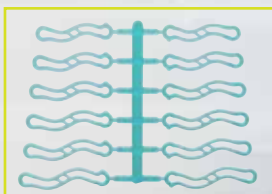

1

The upper splint of the Silensor-sl can be made from the very comfortable double layer material Erkoloc-pro 3.0 mm or from Erkodur 2.0/3.0 mm.



2

The lower splint of the Silensor-sl has to stay firmly in place, only if enough retention is available the lower splint can be made from the double layer material Erkoloc-pro 3.0 mm. Otherwise from Erkodur 2.0/3.0 mm.



4

3

In the canine area of the upper the connector clicks into place firmly. The connecting area consists only of 3 parts:

- anchor
- connector
- splint

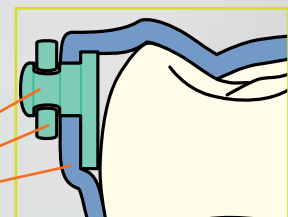

The connectors are easily exchangeable. Hang the connector with its long slot into the anchor and pull it into the end position (fig.).



Use of the sl-protrusion gauge:

Each Silensor-sl parts card carries one single use sl-protrusion gauge.

The construction of the sl-protrusion gauge allows to register directly on the patient the desired or recommended mandibular advancement for the Silensor-sl.

The registration is leading to a sure result. However, if the registration is not possible the Silensor-sl can also be manufactured on occluding models.

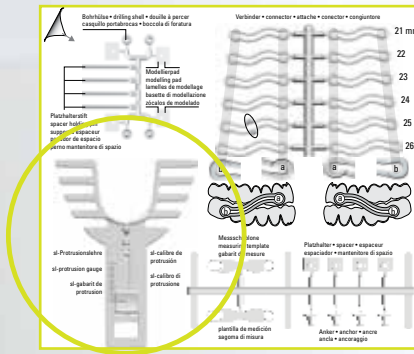

The sl-protrusion gauge allows a precise registration even though the gauge due to its elasticity adapts to the bending of the bite plane. The construction of the gauge allows to remove the registration, in most cases auto-mixed silicone, afterwards. A possible bouncing back of the gauge will not deform the registration for a correct use. This possibility of a non-destructive removal allows the production of registrations which correspond much better to the later device.

The features of the sl-protrusion gauge:

1. protrusion sled
2. elastic registration area
3. conical registration retentions
4. frontal teeth bite area for upper and lower
5. protrusion
6. registrations
7. pulled off registration

Instructions:

1. Clean and assemble the sl-protrusion gauge.

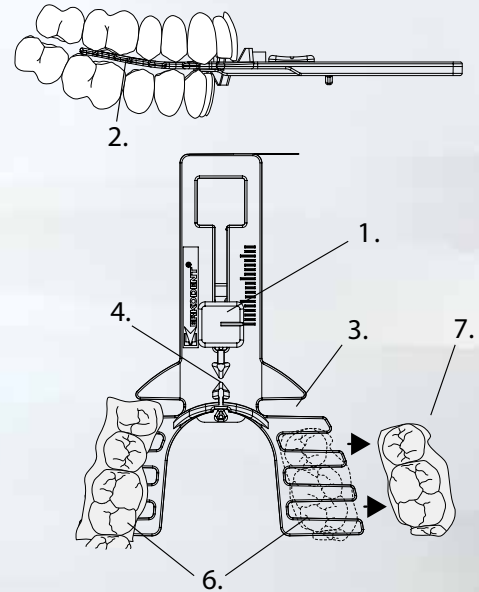
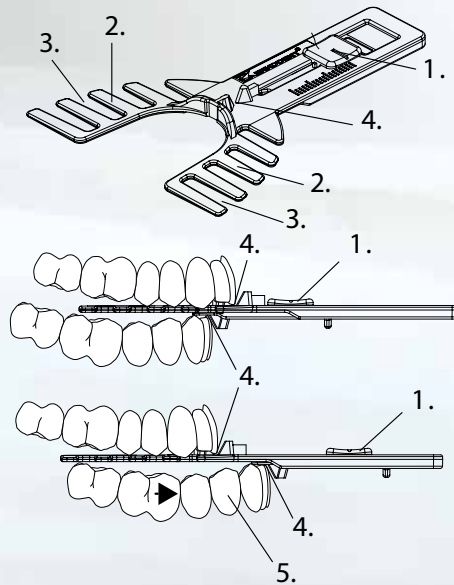
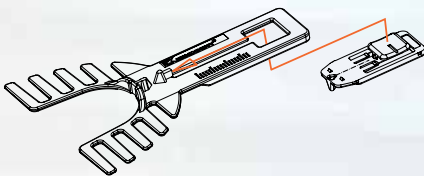

Generally half of the maximum protrusion is recommended as the advanced position of the lower jaw. Is the needed advancement already known drop step 3 and 4. Based on the normal bite position mark the advancement on the gauge and continue with step 5.



2. Insert the sl-protrusion gauge, watch the centre of the frontal teeth.

3. Mark the habitual bite situation. Push under control the lower into the max. protrusion.

4. Mark the max. protrusion. Remove the gauge and mark the desired protrusion.

5. Adjust the gauge to the desired protrusion, insert ...

6. ... and register.

Gauge with removed registration.

Worth knowing:

What are the conditions for a successful therapy with the Silensor-sl?

- absence of inflammatory, painful temporomandibular joint problems
- firm tooth anchoring
- minimum 8 teeth per jaw
- no prognathic bite, class 3
- the BMI (Body-Mass-Index) should not be more than 30 (BMI= body weight (kg) divided by body size (m) x 2)

What are the possible side effects?

Tooth movements, the splint has to compass all teeth, a firm attachment apparatus is required.

Morning malocclusion, after removal of the splint the patient feels a more or less considerably changed bite situation until the reorientation of the masticatory musculature. It is very individual how long this lasts. However, this does not have any consequences according to several studies.

Periodontic pain, the splint is too tight.

Excessive salivation, the more voluminous the construction is the stronger the salivation is. After a certain time of wearing, however, a reduction of the salivation can be assumed.

Order numbers:

Silensor-sl set, English (EN):	
Silensor-sl set, Ø 120 mm	59 60 11
Silensor-sl set, Ø 125 mm	59 60 16
Silensor-sl set, 125x125 mm	59 60 36
Silensor-sl parts card, 1 pc.	59 60 01
Silensor-sl parts card, 10 pcs	59 60 00
Silensor-sl parts card, 40 pcs	59 60 40
sl-protrusion gauge, 5 pcs	59 61 05
sl-protrusion gauge, 20 pcs	59 61 20

Contents Silensor-sl set 59 60 11:

1 fabricating instructions Silensor-sl, 2 info exchange of a connector, 10 Silensor-sl patient flyer, 2 Erkodur 2.0 mm, 1 Erkoloc-pro 3.0 mm, 1 Erkolen 1.0 mm, 1 Erkoloc-pro blu 3.0 mm, 1 boardmarker red, 1 HSS twist drill, Ø 1.4 mm, 1 sample Erkoskin, 1 sample Erkogum violet, blocking out material, 1 sample blocking out wax lilac, highfusing, 2 Silensor-sl parts cards, each 1 bite-help strip and instructions per ErkoBox (2 x)